

Acoustic Lighting Catalog



NO BOUNDARIES



BuzziSpace

— Happiness Is The Key to Success



Content Table

5	About BuzziSpace
13	Understanding Acoustics
17	Acoustic Lighting Portfolio
25	Products
89	Take a Look Around
99	Lighting Specifications
131	Acoustic Expertise
139	Materials
165	Contact



Our Brand

Happy & Healthy Workspaces Around the World

Since its inception in 2007, BuzziSpace's driving force has been to produce effective and high-quality acoustic solutions, lighting, and furniture for the ever-changing workspace that are both functional and inspiring. Our products help reduce excessive noise so people can

feel more focused, less stressed, and thrive better in professional environments. This, in turn, has fueled our mission in creating happy and healthy workspaces, along with increasing the well-being and job satisfaction of employees worldwide.





We Care

Make It Sustainable

Our first BuzziProducts came to life from recycled and recyclable materials, both of which are good for acoustics and the planet. We are conscious of our environmental impact and will collaborate to achieve continuous improvements in

lowering our carbon footprint. In the long run, we would like to produce less waste in order to create a sustainable future for our people, customers, and communities. This is why we invest in handcrafting durable products with high-quality materials.





Craftsmanship

We Have Over 100 Years of Combined Expertise

We believe in craftsmanship and take pride in the details. With over 100 years of combined experience, our hardworking team pieces together our celebrated solutions, most of them by hand, with an eye for detail and great

precision daily. The longevity of materials used, acoustic properties, and aesthetics are our guiding principles in everything we do. With craftsmanship and timeless design at the forefront, we aim to create products that last.





Innovation

We Believe in Creativity Without Boundaries

In our quest to create boundary-pushing acoustic solutions to meet the ever-changing needs of the modern workspace, our passionate in-house design team, BuzziSpace Studio, is fully committed to innovation.

We additionally collaborate with internationally renowned designers to go beyond what is expected in the design world. Rest assured, we are continuously progressing and innovating to meet our challenges.



Acoustic Principles

To create a better acoustical environment and reduce reverberation time in a room, BuzziSpace products are developed to perform on one or more of the following acoustic principles.



Absorption

Sound waves are absorbed by any 'acoustically soft' material they encounter.

Sound is energy, and in order to stop this energy from propagating, absorptive panels help to convert this energy into heat through friction. The absorption coefficient of a product will determine the level and quality of absorption. Absorption applies to a fixed wall or ceiling element.



Diffusion

Sound energy is spread evenly in a given space.

Wavelengths that cannot be absorbed through acoustic treatment will scatter evenly back into the room, ensuring a better spread while maintaining a live, vivid sound. This principle can be obtained by alternating different depths of absorptive material and 3D shapes in the room.



Attenuation

Reducing the sound transfer within a room.

In order to reduce sound transfer between different spaces, vertical elements will be applied to cut down sound energy. These solutions can come in different shapes such as sound blocks, vertical ceiling panels, room dividers and desk screens. Attenuation or sound dampening has a positive impact on speech intelligibility and clarity.





Acoustic Performance

The wavelength determines the sound frequency. It is measured as the number of repetitive vibrations per cycle per second and is expressed in Hertz. The audible range of sound is between 20 to 20,000 Hz. The higher the frequency, the higher the tone.



Low Tones

Long wave - Low frequency
(50 - 250 Hz)

E.g. heating systems,
ventilation, elevators, copy
machines, and server rooms.



Mid Tones

Mid length wave - Speech
frequency (250 - 2500 Hz)

E.g. speech, vowels, and
consonants.



High Tones

Short wave - High frequency
(2500 - 12000 Hz)

E.g. ringtones, typing
sounds, clicking sounds, and
children's speech.

Reverberation Time

It is the time needed for an original sound source to decay to 60 dB and it is expressed in seconds. In order to generate excellent speech intelligibility and clarity, the reverberation time should be adjusted and balanced using absorptive material in the function of specific acoustical issues in a given space.

Recommended Reverberation Times:

Office:	0.75s
Meeting room:	0.60s
Cafeteria:	1.00s
Gymnasium:	1.50s
Auditorium:	1.50s to 2.00s











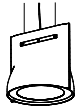
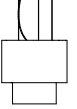

Acoustic Lighting Portfolio





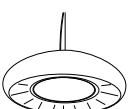

Discover our lauded range of acoustic lighting, expertly designed to create well-balanced work settings and Hubs for Togetherness, whether it be for a collaboration zone, meeting area, social space, or at home.



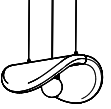







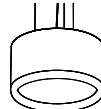

In the following pages, you'll find all the information you need from light sources, power, and glare ratings, among other specifications to help you choose the perfect lighting solution.

ACOUSTIC
LIGHTING
PORTFOLIO





	BuzziBell		BuzziChandelier	
				
	LED Disk Ø 470		Retrofit	
	230 V	120 V	220V 240V	120V
Certifications				
Light Source	LED Board*		Retrofit Bulb incl.	Retrofit Bulb excl.
Light Output	2545 Lm		4800 Lm	/
Power	29,4W		55W	Max. 42W
Efficacy	87 Lm/W		87 Lm/W	/
Color Temperature (Kelvin)	3000K or 4000K (CE/CB)		2700K	/
Color Rendering Index	90		85	/
Unified Glare Rating	22 or 19 (CE/CB)		/	/
Dimmability	1 - 10V or Dali (CE/CB)		Not dimmable	
Source Lifetime	50000 hr		20000 hr	/
Gear / Transfo	incl. in body		incl. in body	





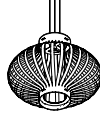
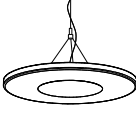

	BuzziDisk		BuzziDome	
				
	LED Disk Ø 450		LED Disk Ø 470	
	220V 240V	120V	230V	120V
Certifications				
Light Source	LED Board		LED Board*	
Light Output	3170 Lm		2545 Lm	
Power	35W		29,4W	
Efficacy	86 Lm/W		87 Lm/W	
Color Temperature (Kelvin)	3000K or 4000K		3000K or 4000K (CE/CB)	
Color Rendering Index	90		90	
Unified Glare Rating	22 or 19		22 or 19 (CE/CB)	
Dimmability	1 - 10V or Dali		1 - 10V or Dali (CE/CB)	
Source Lifetime	50000 hr		50000 hr	
Gear / Transfo	incl. in body		incl. in body	



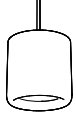
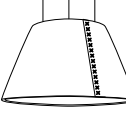

BuzziChip			BuzziCone	
				
LED Globe/Spot Solo			LED Globe/Spot Solo	
220V 240V	110V 120V		220V 240V	110V 120V
				
LED C.O.B.			LED C.O.B.	
1500 Lm			1500 Lm	
32W 19W			32 W 19 W	
46,8 Lm/W 77,5 Lm/W			46,8 Lm/W 77,5 Lm/W	
3000K			3000K	
90			90	
23 (Globe) / 12 (Spot)			23 (Globe) / 12 (Spot)	
1 - 10V or Dali (CE/CB)			1 - 10V or Dali (CE/CB)	
50000 hr			50000 hr	
incl. in ceiling canopy			incl. in ceiling canopy	





BuzziFez		BuzziHat		BuzziJet		BuzziJet Standing	
							
LED		LED Disk Ø 460		LED Disk Ø 470		LED Disk Ø 670	
100V	240V	230V	120V	230V	120V	230V	120V
							
LED Board		LED Board*		LED Board*		LED Board*	
330 Lm		2000 Lm		2545 Lm		6232 Lm	
4,5W		19W	26W	29,4W		70W	
73 Lm/W		105 Lm/W	77 Lm/W	87 Lm/W		89 Lm/W	
2700K		3000K***		3000K or 4000K (CE/CB)		3000K	
90		80		90		90	
/		20 or 19 (CE/CB)		22 or 19 (CE/CB)		23	
Touchdimmer		1 - 10V**		1 - 10V or Dali (CE/CB)		1 - 10V	
50000 hr		50000 hr		50000 hr		50000 hr	
incl. on wire		incl. in body		incl. in body		incl. in body	

ACOUSTIC LIGHTING PORTFOLIO

	BuzziLight Mono	BuzziMoon	BuzziPleat Light
			
	Retrofit 220V 110V 240V 120V	LED Disk Ø 470 230V 120V	LED Globe/Spot Solo 220V 110V 240V 120V
Certifications	CE 	CE 	CE 
Light Source	Retrofit Bulb excl.	LED Board*	LED C.O.B.
Light Output	/	2545 Lm	1500 Lm
Power	Max. 60W Max. 100W	29,4W	32W 19W
Efficacy	/	87 Lm/W	46,8 Lm/W 77,5 Lm/W
Color Temperature (Kelvin)	/	3000K or 4000K (CE/CB)	3000K
Color Rendering Index	/	90	90
Unified Glare Rating	/	22 or 19 (CE/CB)	23 (Globe) / 12 (Spot)
Dimmability	/	1 - 10V or Dali (CE/CB)	1 - 10V or Dali (CE/CB)
Source Lifetime	/	50000 hr	50000 hr
Gear / Transfo	/	incl. in body	incl. in ceiling canopy

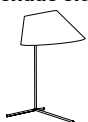
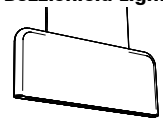
BuzziProp			BuzziShade		
					
LED Globe/Spot Solo 220V 110V 240V 120V	Retrofit 220V 110V 240V 120V	LED Globe/Spot Trio 220V 110V 240V 120V	Retrofit 220V 110V 240V 120V	LED Globe/Spot Solo 220V 110V 240V 120V	LED Disk Ø 470 230V 120V
CE 	CE 	CE 	CE 	CE 	CE 
LED C.O.B.	Retrofit Bulb excl.	LED C.O.B.	Retrofit Bulb excl.	LED C.O.B.	LED Board*
1500 Lm	/	3 x 1500 Lm	/	1500 Lm	2545 Lm
32W 19W	Max. 60W Max. 100W	48,9W 60W	Max. 60W Max. 100W	32W 19W	29,4W
46,8 Lm/W 77,5 Lm/W	/	92 Lm/W 75Lm/W	/	46,8 Lm/W 77,5 Lm/W	87 Lm/W
3000K	/	3000K	/	3000K	3000K or 4000K (CE/CB)
90	/	90	/	90	90
23 (Globe) / 12 (Spot)	/	23 (Globe) / 12 (Spot)	/	23 (Globe) / 12 (Spot)	22 or 19 (CE/CB)
1 - 10V or Dali (CE/CB)	/	1 - 10V	/	1 - 10V or Dali (CE/CB)	1 - 10V or Dali (CE/CB)
50000 hr	/	50000 hr	/	50000 hr	50000 hr
incl. in ceiling canopy	/	incl. in ceiling canopy	/	incl. in ceiling canopy	incl. in body





	BuzziShade Square		
			
	Retrofit 220V 110V 240V 120V	LED Globe/Spot Solo 220V 110V 240V 120V	LED Globe/Spot Trio 220V 110V 240V 120V
Certifications	CE 	CE 	CE 
Light Source	Retrofit Bulb excl.	LED C.O.B.	LED C.O.B.
Light Output	/	1500 Lm	3 x 1500 Lm
Power	Max. 60W Max. 100W	32W 19W	48,9W 60W
Efficacy	/	46,8 Lm/W 77,5 Lm/W	92 Lm/W 75Lm/W
Color Temperature (Kelvin)	/	3000K	3000K
Color Rendering Index	/	90	90
Unified Glare Rating	/	23 (Globe) / 12 (Spot)	23 (Globe) / 12 (Spot)
Dimmability	/	1 - 10V or Dali (CE/CB)	1 - 10V
Source Lifetime	/	50000 hr	50000 hr
Gear / Transfo	/	incl. in ceiling canopy	incl. in ceiling canopy



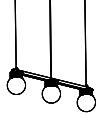
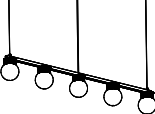
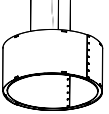

	BuzziShade Standing	BuzziShield Light	
			
	Retrofi 220V 110V 240V 120V	LED Line 85 220V 100V 240V 240/277V	LED Line 125 220V 100V 240V 240/277V
Certifications	CE 	CE 	CE 
Light Source	Retrofit Bulb excl.	LED Line	LED Line
Light Output	/	960 Lm	1400 Lm
Power	Max. 60W Max. 100W	12W 15W	17,5W 21W
Efficacy	/	80 Lm/W 64 Lm/W	80 Lm/W 67 Lm/W
Color Temperature (Kelvin)	/	3000K***	3000K***
Color Rendering Index	/	90	90
Unified Glare Rating	/	/	/
Dimmability	/	0 - 10V or Dali (CE/CB)	0 - 10V or Dali (CE/CB)
Source Lifetime	/	50000 hr	50000 hr
Gear / Transfo	/	incl. in ceiling canopy	incl. in ceiling canopy

* in collaboration with Modular Lighting Instruments
 ** Dali on request
 *** other CCT values on request

For any updates, please refer to the online version of the Acoustic Lighting catalog via www.buzzi.space. The online version will take precedence.

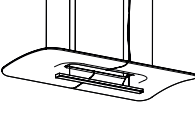
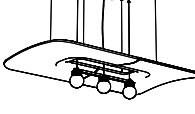
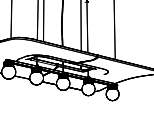
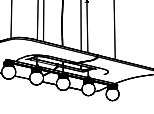
ACOUSTIC
LIGHTING
PORTFOLIO

	BuzziSol				BuzziTrom			
								
	LED Globe/Spot Solo		LED Globe/Spot Trio		LED Globe/Spot Quintet		LED Disk Ø 470	
	220V 240V	110V 120V	220V 240V	110V 120V	220V 240V	110V 120V	230V	120V
Certifications	CE 		CE 		CE 		CE 	
Light Source	LED C.O.B.		LED C.O.B.		LED C.O.B.		LED Board*	
Light Output	1500 Lm		3 x 1500 Lm		5 x 1500 Lm		2545 Lm	
Power	32W	19W	48,9W	60W	81,5 W	90W	29,4W	
Efficacy	46,8 Lm/W	77,5 Lm/W	92 Lm/W	75 Lm/W	92 Lm/W	83 Lm/W	87 Lm/W	
Color Temperature (Kelvin)	3000K		3000K		3000K		3000K or 4000K (CE/CB)	
Color Rendering Index	90		90		90		90	
Unified Glare Rating	23 (Globe) / 12 (Spot)		23 (Globe) / 12 (Spot)		23 (Globe) / 12 (Spot)		22 or 19 (CE/CB)	
Dimmability	1 - 10V or Dali (CE/CB)		1 - 10V		1 - 10V		1 - 10V or Dali (CE/CB)	
Source Lifetime	50000 hr		50000 hr		50000 hr		50000 hr	
Gear / Transfo	incl. in ceiling canopy		incl. in ceiling canopy		incl. in ceiling canopy		incl. in body	

BuzziZepp Light							
							
LED Line 113		LED Line 225		LED Globe/Spot Trio		LED Globe/Spot Quintet	
230V	120V	230V	120V	220V 240V 120V	110V	220V 240V 120V	110V
CE 		CE 		CE 		CE 	
LED Line*		LED Line*		LED C.O.B.		LED C.O.B.	
2300 Lm		4600 Lm		3 x 1500 Lm		5 x 1500 Lm	
33W		65W		48,9 W	60W	81,5W	90W
71 Lm/W		71 Lm/W		92 Lm/W	75 Lm/W	92 Lm/W	83 Lm/W
3000K***		3000K***		3000K		3000K	
90		90		90		90	
23		23		23 (Globe) / 12 (Spot)		23 (Globe) / 12 (Spot)	
1 - 10V**		1 - 10V**		1 - 10V		1 - 10V	
50000 hr		50000 hr		50000 hr		50000 hr	
incl. in ceiling canopy		incl. in ceiling canopy		incl. in ceiling canopy		incl. in ceiling canopy	

Products



BuzziBell — 26



BuzziChandelier — 28



BuzziChip — 30



BuzziCone — 32



BuzziDisk — 34



BuzziDome — 36



BuzziFez — 38



BuzziHat — 41



BuzziJet — 45



BuzziJet Standing — 48



BuzziLight Mono — 50



BuzziMoon — 53



BuzziPleat Light — 57



BuzziProp — 60



BuzziShade — 65



BuzziShade Square — 69



BuzziShade Standing — 72



BuzziShield Light — 75



BuzziSol — 78



BuzziTrom — 82



BuzziZepp Light — 84



BuzziBell

— By Chris Hardy

A noise-absorbing pendant light

BuzziBell's joyful bell shape adds softness to any workspace and can be fitted with a diffused light source or high-performance LED engine. The solution's delicate design is crafted from BuzziFelt, which allows it to effectively absorb excessive noise.



Model

Front

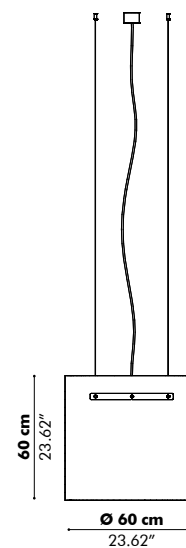

Side

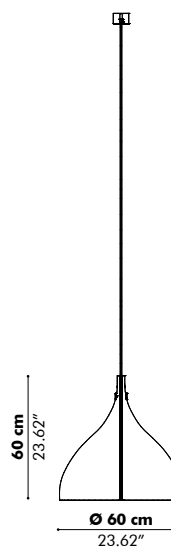

Light

Input Voltage: 230V / 120V
 Input Frequency: 50/60Hz
 Lumen output: 2545 Lm
 Color temperature: 3000K or 4000K (CE/CB)
 Color Rendering Index: 90
 Dimming: 1 - 10V or Dali (CE/CB)
 Diffuser: milky (URG22) or prismatic (UGR19) (CE/CB)
 CE/CB certified / cULus listed

LUX levels

To light up your space with optimal LUX levels, take the following measurements into account.

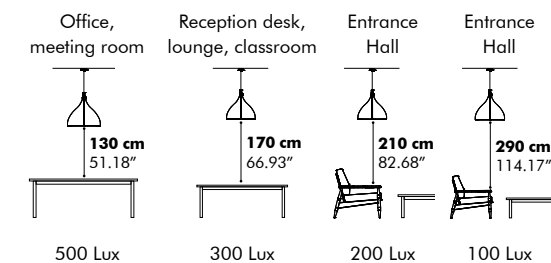

According to EN12464 (only on LUX levels) at full output

How to order

BuzziFelt* color
 Color frame
 Mounting option

* Not available in Ecobrown 58 and Pink 65

Finishes

Metal frame in black (RAL 9005), white (RAL 9010) or fluo yellow (RAL 1016)
 Cover in BuzziFelt
 (Check our application overview p. 138)

Mounting

White metal ceiling canopy and transparent power cable incl.



Ceiling Suspended.
 Fixing System Screw with 2 cables of 2 m - 78.74" or 4 m - 157.85" (black or alu)



BuzziChandelier

— By Sas Adriaenssen

A modern classic

BuzziChandelier is a contemporary take on the Moorish lantern made from BuzziFelt, providing a serene atmosphere to a space while improving the acoustics. This pendant light reinterprets the traditional lantern, combining light and sound absorption.



Model

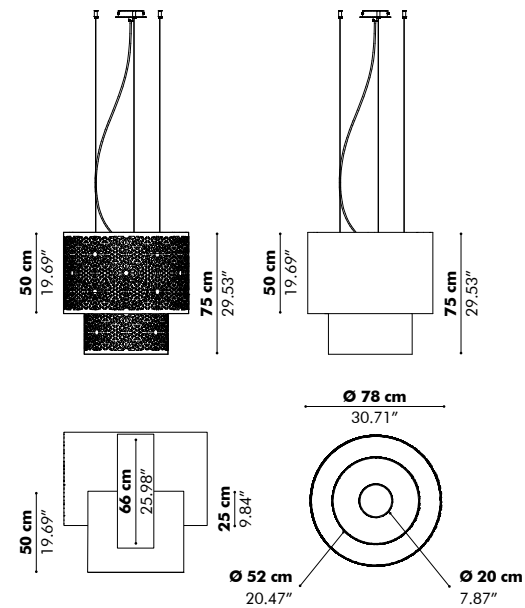

Finishes

Metal frame in black (RAL 9005)
 Shades in BuzziFelt or BuzziFelt printed
 (Gold, Carrara, Emperador)
 (Check our application overview p. 138)

Mounting

Black metal ceiling canopy and black fabric power cable incl.



Ceiling Suspended
 Fixing System Screw with 3 cables of 2 m - 78.74"
 or 5 m - 196.85" (black or alu)

Light

Input Voltage: 110 - 240V
 4 pin CFL Bulb with 2G11 base included 55W (EU-CE certified)
 Bulb excluded (US-cULus listed)

How to order

Model
 BuzziFelt finish
 Mounting option



BuzziChandelier in Printed Felt Gold, Carrara and Emperador.



BuzziChandelier Plain in Printed Felt Gold, Carrara and Emperador.



BuzziChip

— By BuzziSpace Studio

A playful acoustic powerhouse

BuzziChip's curved design helps you move away from hard edges while adding a playful touch to any area. Due to its plush exterior, BuzziChip instantly creates cozy environments, whether in an office, hospitality sector, or residential area, all while helping to absorb excessive sounds. Combine the different models in various fabrics and colors to form a playful and dynamic ceiling in your workspace.



Model

Small

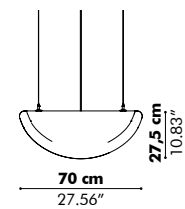

Medium

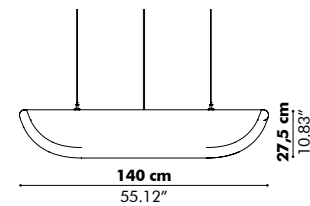

Large

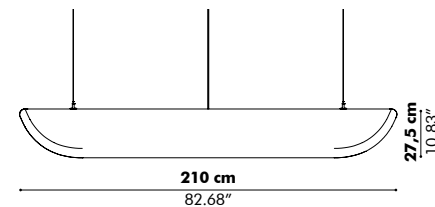

Width: 66 cm | 25.98"

Finishes

Upholstery in fabric collections CAT A, B, C, D and E
LED light source with powder-coated metal heatsink and ceiling canopy in black (RAL 9005)
Black fabric power cable
(Check our application overview p. 138)

Mounting

Black metal ceiling canopy and black fabric power cable incl.



Ceiling Suspended
Fixing System Screw with 2 cables of 2 m - 78.74" or 5 m - 196.85" (black or alu)

Light

Diffuser: glass globe or reflector spot
Input Voltage: 110 - 240V
Input Frequency: 50/60Hz
Lumen Output:
Small: 1500 Lm - Medium: 3 x1500 Lm- Large: 5 x1500 Lm
Color Temperature: 3000K
Color Rendering Index: 90
Dimming: 1 - 10V or Dali on request (Only for Small)
CE/CB certified / cULus listed

How to order

Size
Light option
Fabric (CAT > collection > color)
Mounting option



Combine the different models to form a playful and dynamic ceiling in your workspace.

BuzziCone

— By BuzziSpace Studio

An iconic lighting solution

This cone-shaped pendant light manages to find the perfect balance between being a decorative element and a powerful acoustic performer. Select a LED Globe for mood lighting or a LED Spot, which offers direct functional light for any workstation.



Models

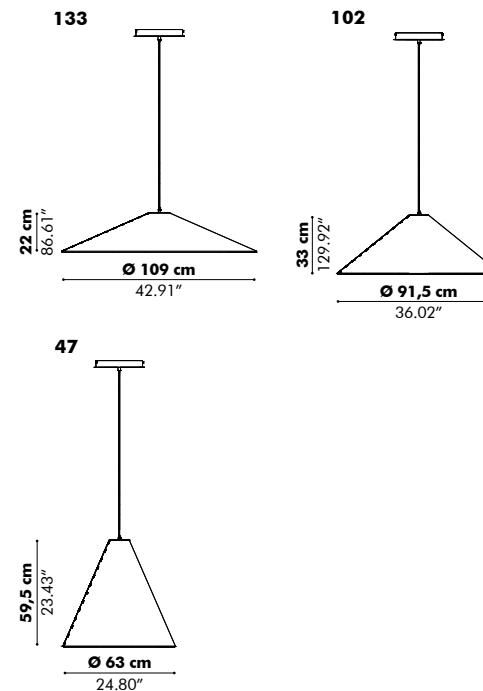

Finishes

Metal frame in black (RAL 9005)
Shade in one layer of BuzziFelt finished with push buttons in glossy black
Extra layer in fabric collection CAT A, C possible inside or outside
(Check our application overview p. 138)

Mounting

Black metal ceiling canopy and black fabric power cable.



Ceiling Suspended
Fixing System Screw with 1 cable of 2 m or 5 m - 196.85" (black)

Light



Retrofit

Excl. lightbulb
E27, max 60W (EU)
E26, max 100W (US)
CE/CB certified / cULus listed

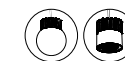

LED Globe
LED Spot

Diffuser: Glass Globe or Reflector Spot
Input Voltage: 110 - 240V
Input Frequency: 50/60Hz
Lumen Output: 1500 Lm
Color Temperature: 3000K
Color Rendering Index: 90
Dimming: 1 - 10V or Dali (CE/CB)
CE/CB certified / cULus listed

LUX levels

LED Spot

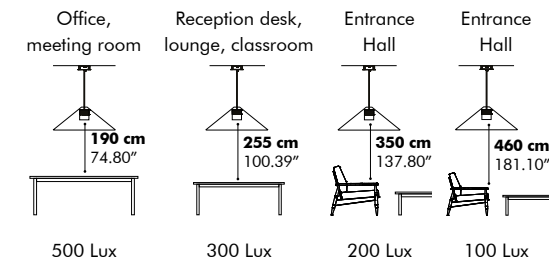

LED Globe

Only for decorative lighting effect

How to order

Model / Size
BuzziFelt Color
Option with extra layer fabric
Mounting option
Light option



Glossy bronze push buttons add a modern twist to this lighting solution.



BuzziDisk

— By BuzziSpace Studio

An upholstered light disk

This elevated LED Disk Light features our signature upholstered body, which instantly adds a warm and colorful touch to any office. The functional lighting solution can be ceiling suspended or ceiling mounted to liven up your workspace.

Model

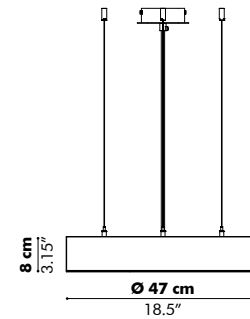

Finishes

Metal body in white (RAL 9010)
Upholstered Ring in fabric collection CAT A
(Check our application overview p. 138)

Mounting

Ceiling Suspended

Black metal ceiling canopy and Black Fabric power cable incl.



Ceiling Suspended Straight
Fixing System Screw with 3 cables of 2 m - 78.74" or 5 m - 196.85" (black or alu)



Ceiling Suspended Split (Only for S and M)
Fixing System Screw with 3 split cables and 1 main cable, total length of 2 m - 78.74" or 5 m - 196.85" (black or alu)

Ceiling Mounted

Light

Input Voltage: 220V-240V / 120V
Input Frequency: 50/60Hz
Lumen Output: 3170 Lm
Color temperature: 3000K or 4000K
Color Rendering Index: 90
Dimming: 1 - 10V or Dali
Diffuser: milky (UGR22) or prismatic (UGR19)
CE/CB certified / cULus listed

LUX levels

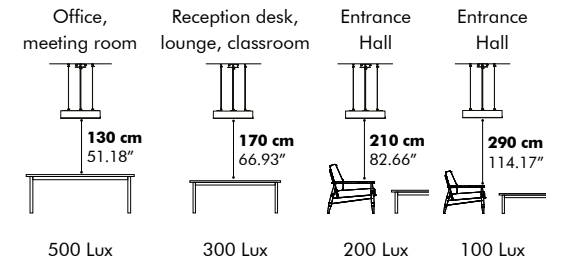

According to EN12464 (only on LUX levels) at full output

How to order

Fabric (collection > color)
Mounting option
Color Temperature
Diffusor Type
Dimming



The upholstered ring securely fits around the product with magnets for a sleek finish.



BuzziDome

— By BuzziSpace Studio

A distinctive and functional light

BuzziDome is a refined, upholstered pendant light that effectively diffuses and absorbs excessive noise. Within BuzziDome's meticulously crafted foam body is a functional light suitable for all workspaces.



Model

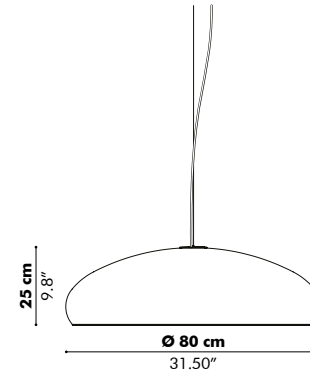

Finishes

Acoustic foam upholstered element with integrated LED disk.
Fabric collections CAT A, B, C, D and E
(Check our application overview p. 138)

Mounting

White metal ceiling canopy and transparent power cable incl.



Ceiling Suspended Straight
Fixing System Screw with 1 cable of 2 m - 78.74"
or 4 m - 196.85" (black or alu)

Light

Input Voltage: 230V / 120V
Input Frequency: 50/60Hz
Lumen Output: 2545 Lm
Color Temperature: 3000K or 4000K (CE/CB)
Color Rendering Index: 90
Dimming: 1 - 10V or Dali (CE/CB)
Diffuser: milky (UGR22) or prismatic (UGR19) (CE/CB)
CE/CB certified / cULus listed



BuzziDome features a luxurious upholstered body.

LUX levels

To light up your space with optimal LUX levels, take the following measurements into account.

Office, meeting room	Reception desk, lounge, classroom	Entrance Hall	Entrance Hall
130 cm 51.18"	170 cm 66.93"	210 cm 82.66"	290 cm 114.17"
500 Lux	300 Lux	200 Lux	100 Lux

According to EN12464 (only on LUX levels) at full output

How to order

Fabric (CAT > collection > color)
Mounting option



BuzziFez

— By BuzziSpace Studio

A playful table lamp

BuzziFez is our first table lamp inspired by our beloved range of acoustic lighting solutions. The miniature light is equipped with an energy-efficient and dimmable LED module that provides tactile warm lighting and features a tiltable cylindrical-shaped head made from our signature BuzziFelt material. This decorative lighting accessory arrives completely assembled.

Model

Tilted head

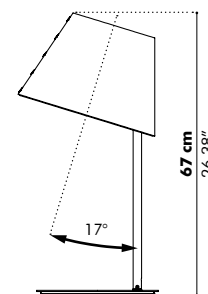

Straight head

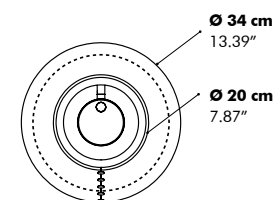
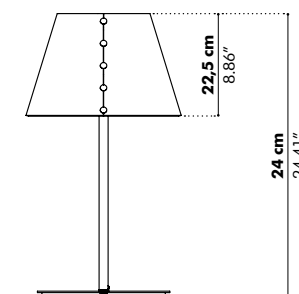

A closer look at BuzziFez's energy-efficient and dimmable LED module.

Finishes

Metal structure in black (RAL 9005) Power cord in black
Shade in BuzziFelt Anthracite, OffWhite or StoneGrey Finished with push buttons in glossy black
Shade inside always in Fabric Ivory
(Check our application overview p. 138)

Light

Wattage: 4.5W
Input Voltage: 100 - 240V
Input Frequency: 60Hz
Lumen Output: 330 lumen
Color Temperature: 2700K
Color Rendering Index: <90
Dimming: Touchdimmer

How to order

Shade color



BuzziHat

— By Alain Gilles

A whimsical pendant light

BuzziHat is playful acoustic pendant light and can be customized in over 24,000 combinations. This ensures you find the right fit, both acoustically and functionally, for your workspace.





A few of BuzziHat's possible combinations.



Mix various combinations to create a vibrant setting.

Models

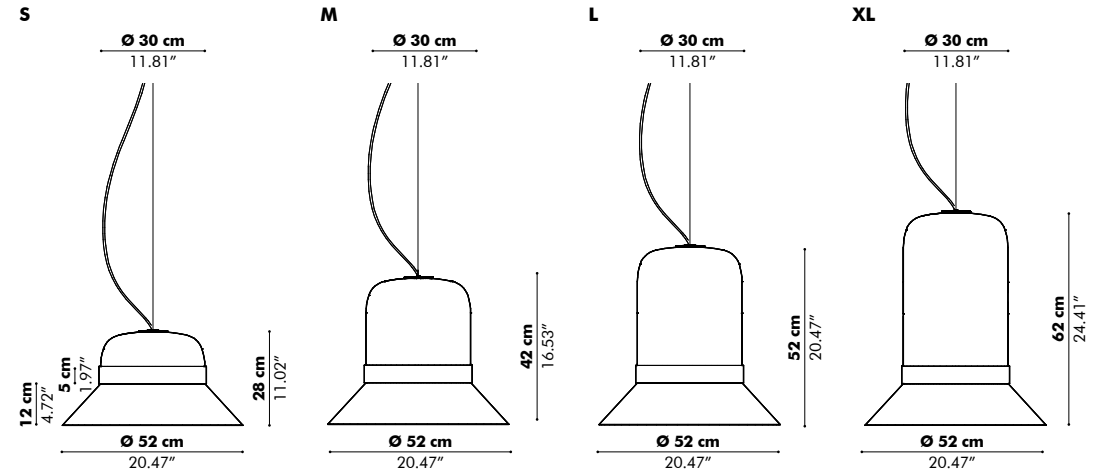

Finishes

Metal Shade and decorative ring in black (RAL 9005), white (RAL 9010), beige red (RAL 3012) or gold
 Upholstery in fabric collections CAT A, B, C, D, E
 (Check our application overview p. 138)

Mounting

White metal ceiling canopy and transparant power cable incl.



Ceiling Suspended.
 Fixing System Screw with 1 cable of 2 m - 78.74"
 or 4 m - 157.48" (black or alu)

Light

Input Voltage: 230V / 120V
 Input Frequency: 50/60Hz
 Lumen Output: 2000 Lm
 Color Temperature: 3000K
 Color Rendering Index: 80
 Dimming: 1 - 10V
 Diffuser: milky (UGR20) or prismatic (UGR19) (CE/CB)
 CE/CB certified / cULus listed

LUX levels

To light up your space with optimal LUX levels, take the following measurements into account.

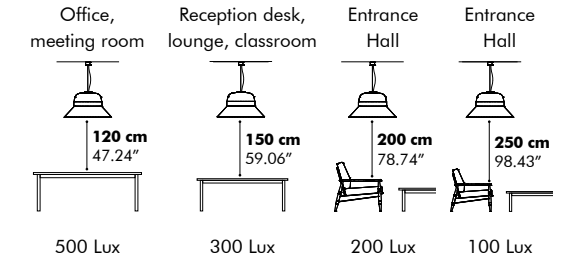

According to EN12464 (only on LUX levels) at full output

How to order

Model
 Fabric (CAT > collection > color)
 Color metal shade
 Color decorative ring
 Mounting option



BuzziJet

— By BuzziSpace Studio

A powerful acoustic light

Form follows function with BuzziJet. Available in four different models, the solution's cylindrical design allows sound waves to bounce back and forth within the radius of its circular body to mitigate noise. Concealed within BuzziJet's foam body is a powerful light source that emits warm pleasant light.



Models

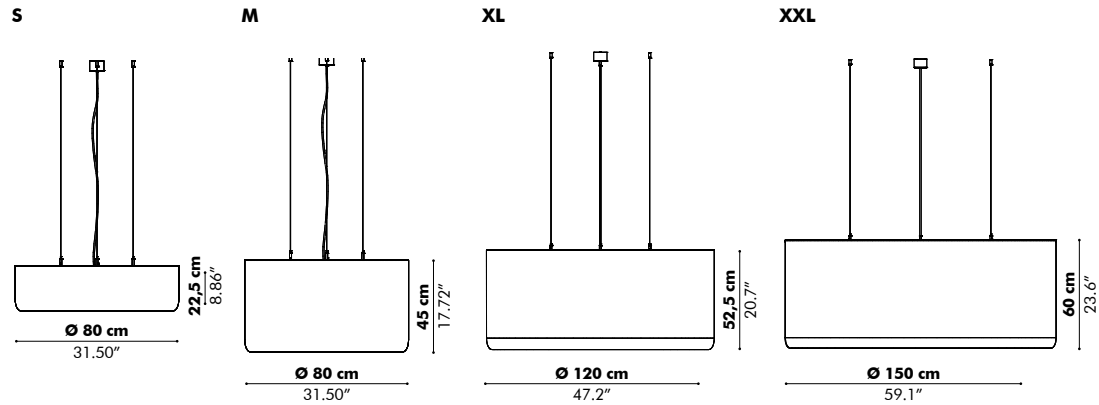

Finishes

Metal frame in white (RAL 9010)

Upholstery in fabric collections CAT A, B, C, D and E
(Check our application overview p. 138)

Mounting

Ceiling Suspended

White metal ceiling canopy and transparent power cable incl.

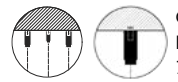

Ceiling Suspended Straight
Fixing System Screw with 3 cables of 2 m - 78.74" or 4 m - 157.48" (black or alu)

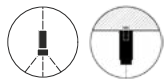

Ceiling Suspended Split (Only for S and M)
Fixing System Screw with 3 split cables and 1 main cable, total length of 2 m - 78.74" or 4 m - 157.48" (black or alu)

Ceiling Mounted

Only for S and M

Light

S, M and XL (Disk Ø 470)

Input Voltage: 230V / 120V

Input Frequency: 50/60Hz

Lumen Output: 2545 Lm

Color temperature: 3000K or 4000K (CE/CB)

Color Rendering Index: 90

Dimming: 1 - 10V or Dali (CE/CB)

Diffuser: milky (UGR22) or prismatic (UGR19) (CE/CB)

CE/CB certified / cULus listed

XXL (Disk Ø 670)

Input Voltage: 230V / 120V

Input Frequency: 50/60Hz

Lumen Output: 6232 Lm

Color temperature: 3000K

Color Rendering Index: 90

Dimming: 1 - 10V

Diffuser: milky (UGR23)

CE/CB certified / cULus listed

LUX levels

To light up your space with optimal LUX levels, take the following measurements into account.

S, M and XL

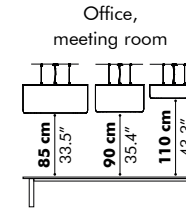

500 Lux

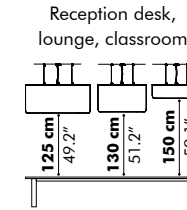

300 Lux

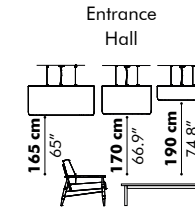

200 Lux

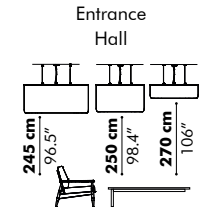

100 Lux

XXL

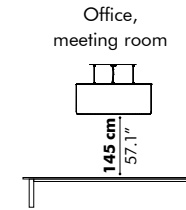

500 Lux

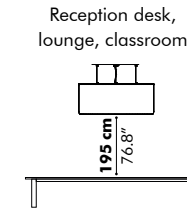

300 Lux

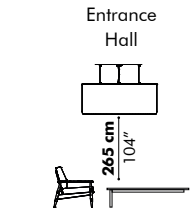

200 Lux

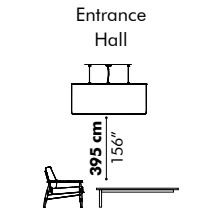

100 Lux

According to EN12464 (only on LUX levels) at full output

How to order

Size

Fabric (CAT > collection > color)

Mounting option



BuzziJet Standing

— By BuzziSpace Studio

An elegant lighting solution

BuzziJet Standing is a functional acoustical lighting solution designed to suit flexible and open spaces. As a solution that requires no installation, this elegant lighting option is also a perfect add-on to any lounge area or break-out zone and can dim to create different atmospheres.



Model

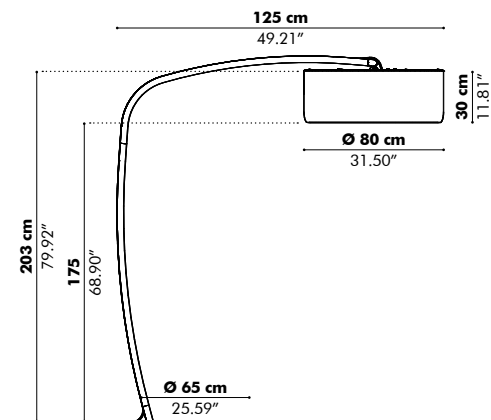

Finishes

Aluminum arch in black (RAL 9005)
 Metal baseplate in black (RAL 9005)
 Upholstered acoustic shade in fabric collection
 CAT A, B, C, D and E
 Fabric power cable in Black or Red
 (Check our application overview p. 138)

Light

Wattage: 21W
 Input Voltage: 120 - 240V
 Input Frequency: 50/60Hz
 Lumen Output: 1900 lumen
 Color Temperature: 3000K
 Color Rendering Index: >95
 Dimming: Floordimmer
 Unified Glare Rating: 22
 CE/CB certified / cULus listed

Lux levels

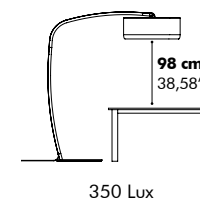

How to order

Fabric (CAT, collection, color)
 Color power cable



BuzziLight Mono

— By Sas Adriaenssen

A lightweight sound-absorber

BuzziLight Mono is a decorative acoustic solution made from a single layer of BuzziFelt. Despite its lightweight design, BuzziLight Mono's felt body provides enough surface area to trap sound waves within to reduce noise in an open space.



BuzziLight Mono features our signature lace detailing.

Model

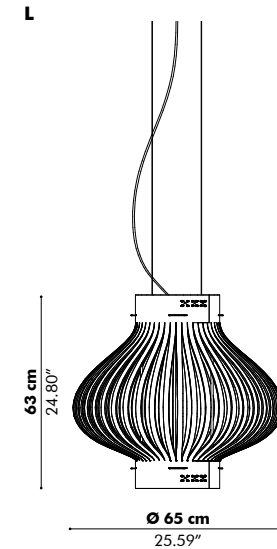

Finishes

Metal frame in black (RAL 9005)
 One layer of BuzziFelt
 Black or white lace
 Black or white stitch or no stitch
 (Check our application overview p. 138)

Mounting

Black metal ceiling canopy and black fabric power cable incl.



Ceiling Suspended.
 Fixing System Screw with 2 cables of 2 m - 78.74"
 or 5 m - 196.85" (black or alu)

Light

Excl. lightbulb
 E27, max 60W (EU-CE/CB certified)
 E26, max 100W (US-cULus listed)

Options

LED bulb E27, 5W (EU)

How to order

BuzziFelt color
 Color lace
 Stitch
 Color
 Mounting option



BuzziMoon

— By BuzziSpace Studio

An Embedded light

BuzziMoon offers the best of both worlds, a highly functional general lighting embedded in a proven acoustic ceiling solution. BuzziMoon is equally performant on lighting as well as on an acoustic level.



Models

Round Small

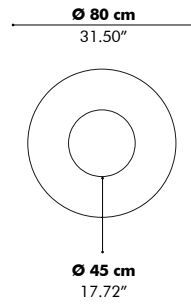

Round Medium

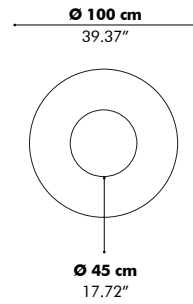

Round Large

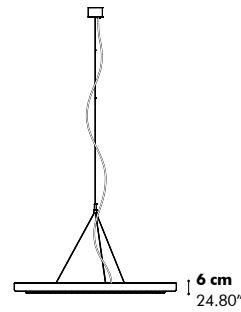
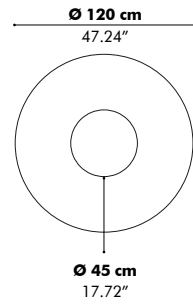

Oval Small

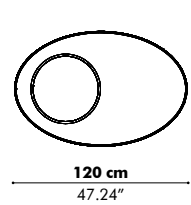

Oval Medium

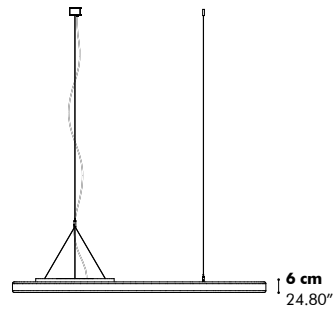
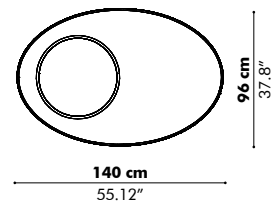

Patterns

Round Flat

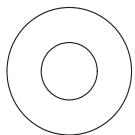

Round Rib

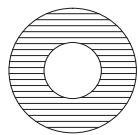

Round Leaf

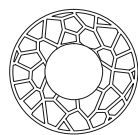

Round Drop

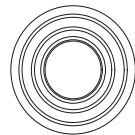

Oval Flat

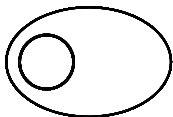

Oval 3D Rib

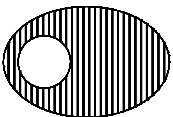

Oval 3D Leaf

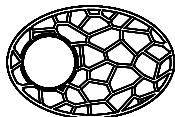

Finishes

Upholstery in fabric collections CAT A, B, C, D, E
(Check our application overview p. 138)

Mounting

Ceiling Suspended

White metal ceiling canopy and transparent power cable.



Ceiling Suspended Split
Fixing System Screw with 3 cables of 4 m -
157.48" (alu)*

*Moon Oval with additional cable & Fixing System Screw.

Ceiling Mounted

Only for model round (from Summer)

Light

Input Voltage: 230V / 120V

Input Frequency: 50/60Hz

Lumen Output: 2545 Lm

Color temperature: 3000K or 4000K (CE/CB)

Color Rendering Index: 90

Dimming: 1 - 10V or Dali (CE/CB)

Diffuser: milky (UGR22) or prismatic (UGR19) (CE/CB)

CE/CB certified / cULus listed

LUX levels

To light up your space with optimal LUX levels, take the following measurements into account.

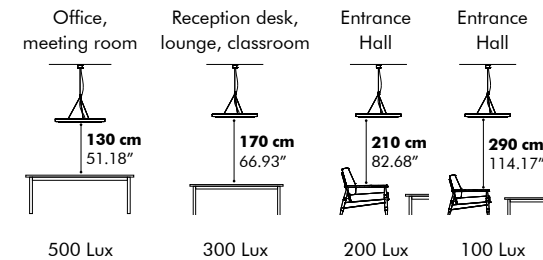

According to EN12464 (only on LUX levels) at full output

How to order

Model and Size

Pattern

Fabric (CAT > collection > color)

Mounting option



A closer look at BuzziMoon's 3D pattern.



Functional lighting embedded in a proven acoustic ceiling solution.



BuzziPleat Light

— By 13&9 Design and BuzziSpace Studio

An avant-garde solution

BuzziPleat Light's sculptural form provides both innovative and exceptional sound-absorbing abilities. Additionally, the solution's architectural folds are a perfect marriage in sound control and design delight.



Models

Ripple M

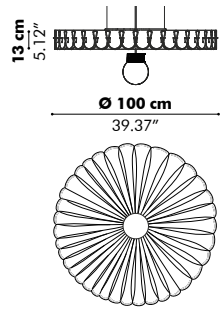

Ripple L

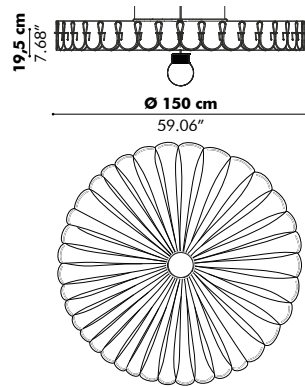

The architectural folds maximize surface area and deliver exceptional acoustic performance.

Edel M

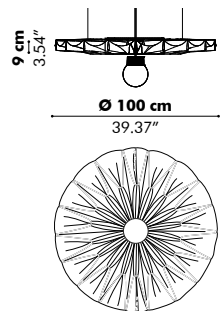

Edel L

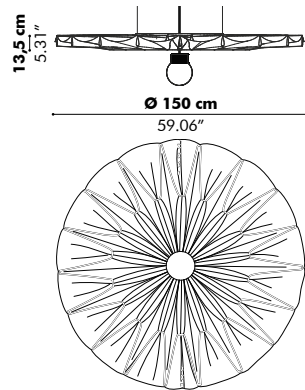

A closer look at BuzziPleat Light's hand-pleated and lacing details.

Edel Long

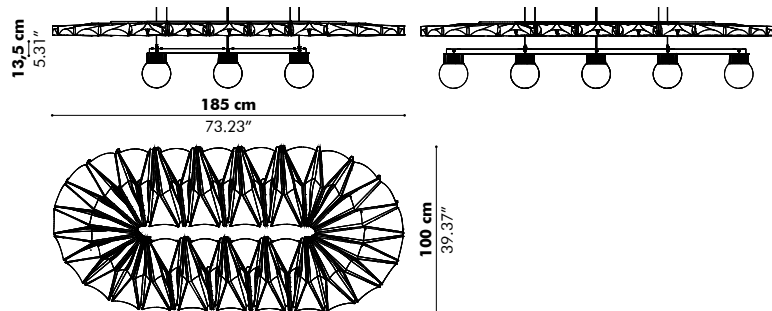

Finishes

Pleat in BuzziFelt: OffWhite, StoneGrey and Anthracite
Lace in OffWhite or Black
LED Light source with powder-coated metal heatsink in black (RAL 9005)
(Check our application overview p. 138)

Mounting

Black metal ceiling canopy and black fabric power cable incl.



Ceiling Suspended.
Fixing System Screw with 3 cables of 2 m - 78.74" or 5 m - 196.85" (black or alu)

Light

Diffuser: glass globe or reflector spot
Input voltage: 110-240V
Input freq: 50/60 Hz
Lumen Output: Solo: 1500 Lm | Trio: 3 x 1500 Lm | Quintet 5 x 1500 Lm
Color Temperature: 3000K
Color Rendering Index: 90
Dimming: 1-10V or Dali on request
LED Light source CE/CB certified / cULus listed



LUX levels

To light up your space with optimal LUX levels, take the following measurements into account.

LED Spot

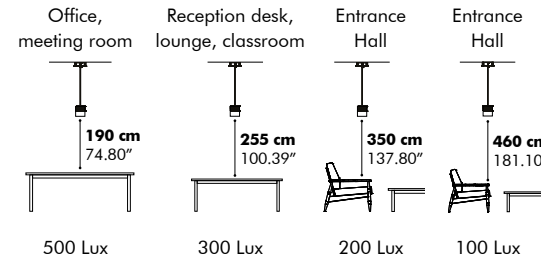

LED Globe

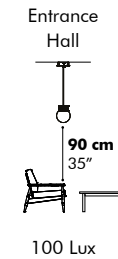

According to EN12464 (only on LUX levels) at full output

How to order

Size
Model
Color lace
Mounting option



BuzziProp

— By BuzziSpace Studio

An aerodynamic noise regulating light

BuzziProp's aerodynamic design offers sound-absorbing capabilities, delivering acoustic comfort paired with a warm ambient light. Both BuzziProp Small and BuzziProp Beam are specifically designed to absorb high-frequency sounds such as ringtones and noise from chatty colleagues.





BuzziProp Beam paired with BuzziSol Trio Globe.



BuzziProp Beam paired with BuzziSol Trio Spot.

Models

Small

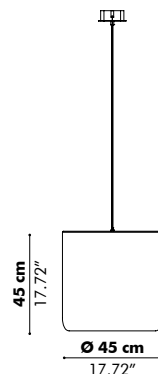

Beam

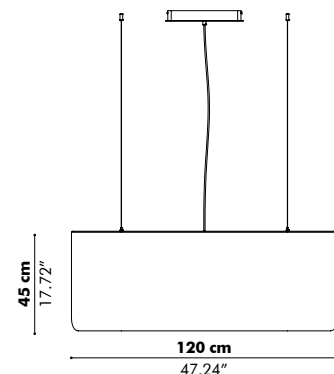

Finishes

Metal frame in black (RAL 9005)
 Upholstery in fabric collections CAT A, B, C, D and E
 LED Light source with powder-coated metal heatsink in black (RAL 9005)
 (Check our application overview p. 138)

Mounting

Black metal ceiling canopy and black fabric power cable incl.



Ceiling Suspended Small
 Fixing System Screw with 1 cable of 2 m - 78.74"
 or 5 m - 196.85" (black or alu)



Ceiling Suspended Beam
 Fixing System Screw with 2 cables of 2 m - 78.74"
 or 5 m - 196.85" (black or alu)

Light

Small



Retrofit

Excl. lightbulb
 E27, max 60W (EU)
 E26, max 100W (US)
 CE/CB certified / cULus listed



LED Globe LED Spot

Diffuser: glass globe
 or reflector spot
 Input Voltage: 110 - 240V
 Input Frequency: 50/60Hz
 Lumen Output: 1500 Lm
 Color Temperature: 3000K
 Color Rendering Index: 90
 Dimming: 1 - 10V or Dali (CE/CB)
 CE/CB certified / cULus listed

Beam

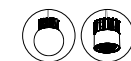

LED Globe LED Spot

Diffuser: glass globe
 or reflector spot
 Input Voltage: 110 - 240V
 Input Frequency: 50/60Hz
 Lumen Output: 3 x 1500 Lm
 Color Temperature: 3000K
 Color Rendering Index: 90
 Dimming: 1 - 10V
 CE/CB certified / cULus listed

LUX levels

To light up your space with optimal LUX levels, take the following measurements into account.

Small Spot

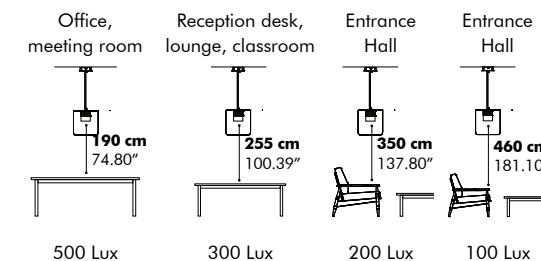

Small Globe

Only for decorative lighting effect.

Beam Spot

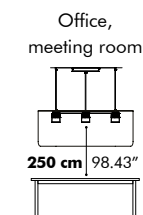

500 Lux

Beam Globe

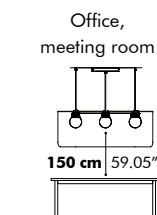

500 Lux

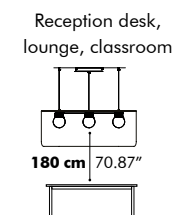

300 Lux

According to EN12464 (only on LUX levels) at full output

How to order

Model
 Fabric (CAT > collection > color)
 Mounting option, light option



BuzziShade

— By BuzziSpace Studio and Stal Collectief

A timeless signature

BuzziShade's timeless design prevents eavesdroppers from hearing your private conversations and reduces external noise levels to a minimum. Our signature noise-reducing pendant accommodates the demand for both sound absorption and light.



Models

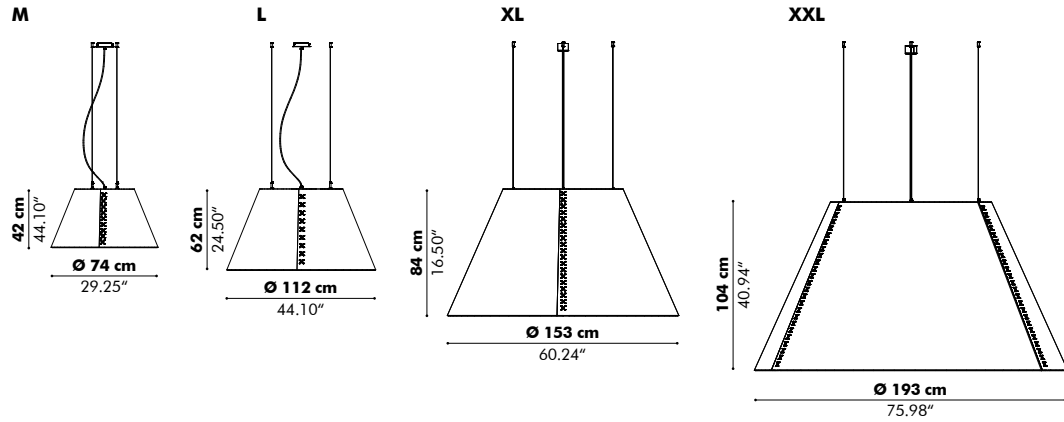

Finishes

Shade in one layer of BuzziFelt
 Extra layer in fabric in CAT A possible inside or outside
 (Check our application overview p. 138)

M/L

Frame in white (RAL 9010), black (RAL 9005),
 fluo orange (RAL 2005) or uncoated aluminum
 Color lace in black, white or fluorescent orange

XL/XXL

Frame in white (RAL 9010), black (RAL 9005),
 or uncoated aluminum
 Color lace in black or white

Mounting

M/L

 Ceiling Suspended
 Fixing System Screw with 2 cables of 2 m - 78.74"
 or 5 m - 196.85" (black or alu)

XL/XXL

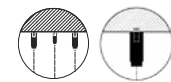
 Ceiling Suspended Straight
 Fixing System Screw with 3 cables of 2 m -
 78.74" or 4 m - 157.48" (black or alu)



A closer look at BuzziShade's coated metal frame and BuzziSol Globe.

Light

M and L



Retrofit

Excl. lightbulb
 E27, max 60W (EU)
 E26, max 100W (US)
 Fabric power cable in black,
 red or orange (CE only)
 Black or white metal
 ceiling canopy
 CE/CB certified / cULus listed

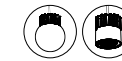

LED Globe LED Spot

Input Voltage: 110 - 240V
 Input Frequency: 50/60Hz
 Lumen Output: 1500 Lm
 Color Temperature: 3000K
 Color Rendering Index: 90
 Diffuser: glass globe or reflector spot
 Dimming: 1 - 10V or Dali on request
 Black metal ceiling canopy. Fabric power
 cable in black
 CE/CB certified / cULus listed

XL and XXL



LED Disk

Input Voltage: 230V / 120V
 Input Frequency: 50/60Hz
 Lumen Output: 2545 Lm
 Color Temperature: 3000K or 4000K (CE/CB)
 Color Rendering Index: 90
 Diffuser: milky (UGR22)
 or prismatic (UGR19) (CE/CB)
 Dimming: 1 - 10V or Dali (CE/CB)
 White metal ceiling canopy. Transparant cable
 CE/CB certified / cULus listed

LUX levels

To light up your space with optimal LUX levels, take the
 following measurements into account.

M/L Spot

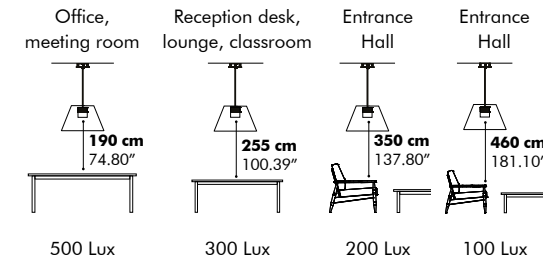

According to EN12464 (only on LUX levels) at full output

M/L Globe

Only for decorative lighting effect

How to order

- Size
- Color frame
- BuzziFelt color
- Option extra layer fabric (CAT > collection > color > inside or outside)
- Color lace
- Light option
- Mounting option
- Color power cable (retrofit)
- Color ceiling canopy (retrofit)



BuzziShade Square

— By BuzziSpace Studio and Stal Collectief

A reinvented classic

Inspired by our signature BuzziShade, BuzziShade Square and BuzziShade Square Beam feature sleek architectural lines. This outstanding acoustic lighting element doubles as a sound-absorbing panel and can be paired with either a LED Globe or Spot iteration of BuzziSol Solo and BuzziSol Trio.



Models

Medium

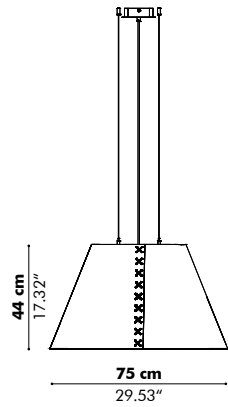

Beam

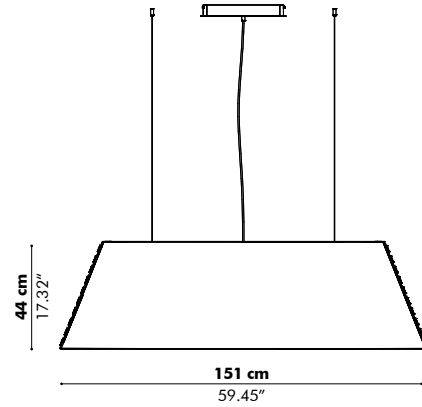

Finishes

Metal frame in black (RAL 9005), white (RAL 9010), uncoated aluminum or fluorescent orange (RAL 2005) (Only for Medium)
 Shade in one layer of BuzziFelt
 Color lace in black, white or fluorescent orange
 (Check our application overview p. 138)

Light

Medium



Retrofit

Excl. lightbulb
 E27, max 60W
 E26, max 100W
 Black metal ceiling canopy
 Fabric power cable in black,
 red or fluorescent orange
 (only CE/CB)
 CE/CB certified / cULus listed



LED Globe LED Spot

Diffuser: glass globe
 or reflector spot
 Input Voltage: 110 - 240V
 Input Frequency: 50/60Hz
 Lumen Output: 1500 Lm
 Color Temperature: 3000K
 Color Rendering Index: 90
 Dimming: 1 - 10V or Dali (CE/CB)
 Black metal ceiling canopy
 Fabric power cable in black
 CE/CB certified / cULus listed

Mounting



Ceiling Suspended
 Fixing System Screw with 2 cables of 2 m - 78.74"
 or 5 m - 196.85" (black or alu)

Beam



LED Globe LED Spot

Diffuser: glass globe or
 reflector spot
 Input Voltage: 110 - 240V
 Input Frequency: 50/60Hz
 Lumen Output: 3 x 1500 Lm
 Color Temperature: 3000K
 Color Rendering Index: 90
 Dimming: 1 - 10V
 Black metal ceiling canopy
 Fabric power cable in black
 CE/CB certified / cULus listed

LUX levels

To light up your space with optimal LUX levels, take the following measurements into account.

Medium Spot

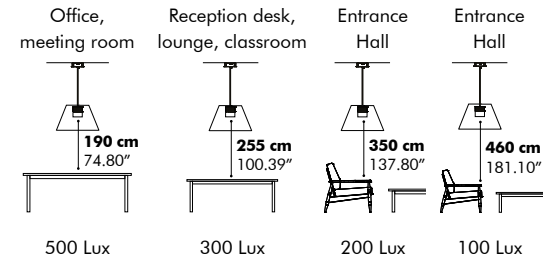

Medium Globe

Only for decorative lighting effect

Beam Spot

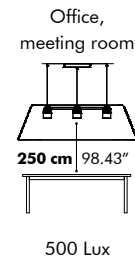

Beam Globe

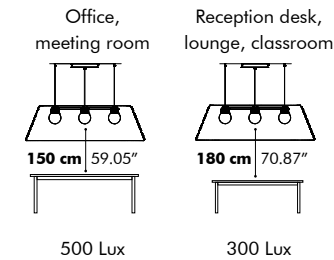

According to EN12464 (only on LUX levels) at full output

How to order

Size
 Color frame
 BuzziFelt color
 Color lace
 Light option
 Mounting option
 Color power cable (retrofit)
 Color ceiling canopy (retrofit)

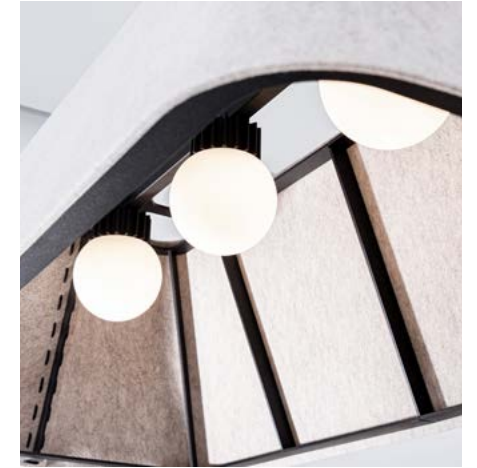

BuzziShade Square Beam paired with BuzziSol Trio Globe.



BuzziShade Standing

— By BuzziSpace Studio and Stal Collectief

A contemporary floor lamp

This noise-reducing floor lamp accommodates the demand for both sound absorption and light. BuzziShade Standing's design prevents eavesdroppers from hearing your private conversations and reduces external noise levels to a minimum.



Models

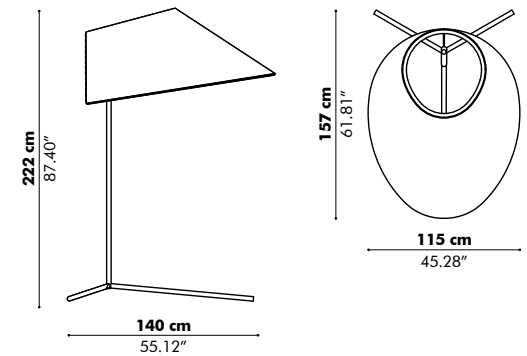

Finishes

Metal frame in white (RAL 9010) or black (RAL 9005)
Power cable in black, red or orange (CE-only)
Shade in one layer of BuzziFelt
Color lace in black, white or fluorescent orange
(Check our application overview p. 138)

Light

Excl. lightbulb
E27, max 60W (EU)
E26, max 100W (US)

How to order

Color frame
BuzziFelt color
Color lace
Color power cable



BuzziShield Light

— By BuzziSpace Studio

A voluminous powerhouse

BuzziShield Light is our latest boundary-pushing solution that elegantly combines the acoustic capabilities of a voluminous body with the addition of functional lighting. Our first linear lighting solution is an acoustic powerhouse suited for any workspace and Hubs for Togetherness setting. And with six different sizes, you can easily absorb excessive noise in style.



Models

Medium

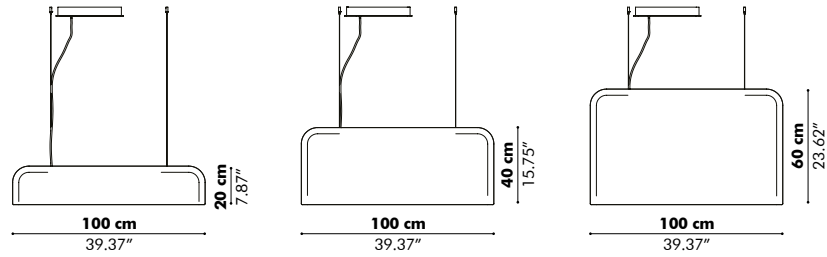

Large

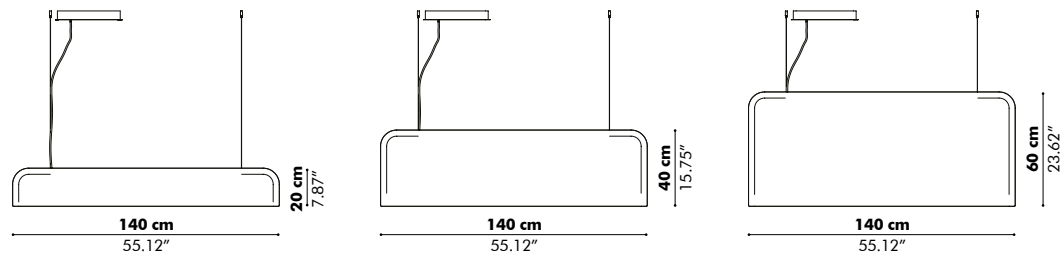

Finishes

Upholstery in fabric collections CAT A, B, C, D and E
 LED Line embedded in aluminium white profile (RAL 9010) |
 Milky diffuser
 Powder coated metal ceiling canopy in black (RAL 9005)
 Black fabric power cable
 (Check our application overview p. 138)

Mounting

Black metal ceiling canopy and black fabric power cable incl.



Ceiling Suspended.
 Fixing System Screw with 2 cables of 2 m - 78.74"
 or 5 m - 196.85" (black)

Light

Input Voltage 220 - 240V / 100 - 240/277V
 Input Frequency 50/60Hz
 Lumen Output M: 960 Lm
 Lumen Output L: 1400 Lm
 Color Temperature: 3000K
 Color Rendering Index: 90
 Dimming: 0-10V or DALI (CE/CB)
 Diffusor: milky (UGR22)
 CE/CB certified / cULus Listed

LUX levels

Medium

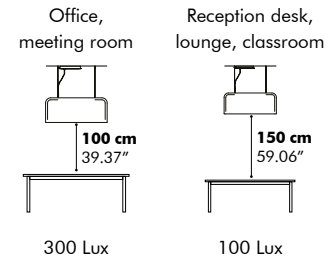

Large

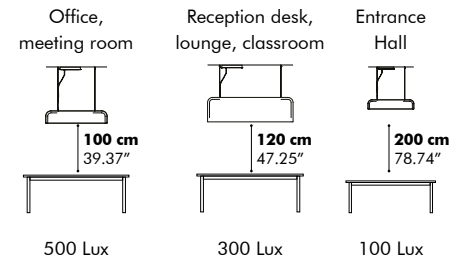

According to EN12464 (only on LUX levels) at full output

How to order

Size
 Height
 Fabric (cat > collection > color)
 Mounting option



BuzziShield Light features a voluminous body.



BuzziSol

— By BuzziSpace Studio

A versatile lighting family

BuzziSol is a versatile and straightforward pendant light fixture that can be fitted with either a frosted glass globe for ambient settings or a reflective spot for direct lighting. BuzziSol Solo is designed for smaller settings, while BuzziSol Trio and BuzziSol Quintet variations suit larger gathering spots and collaboration areas. BuzziSol can be used as a standalone or paired with a selection of our acoustic lighting elements.

Models

Solo Spot

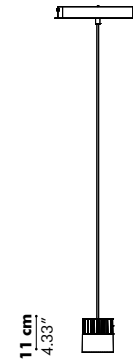

Trio Spot

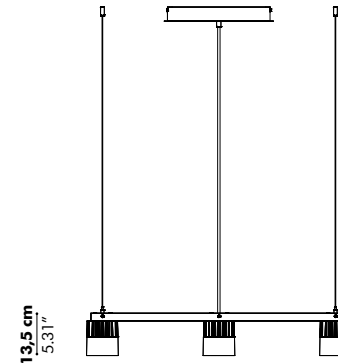

Quintet Spot

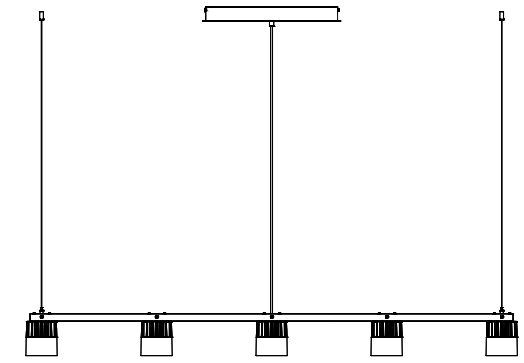

Solo Globe

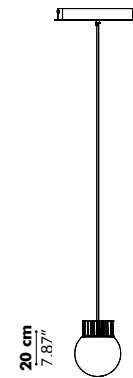

Trio Globe

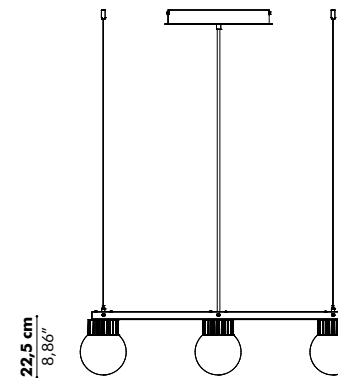

Quintet Globe

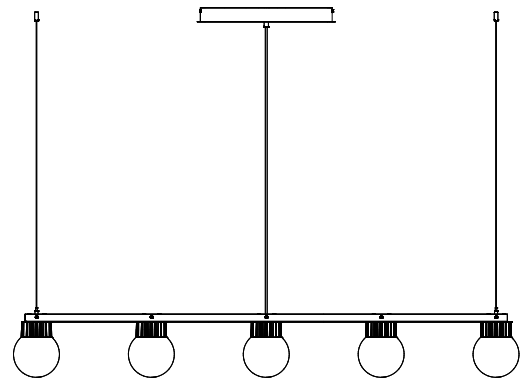

Globe

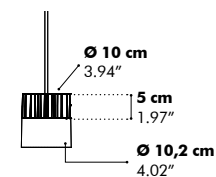

Spot

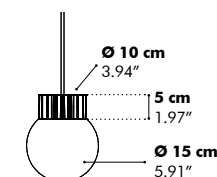

Finishes

Powder-coated metal heatsink and ceiling canopy in black (RAL 9005)
Black fabric power cable

Mounting



Ceiling Suspended
Trio & Quintet: Fixing system with 2 cables of 2 m - 78.74" or 5 m - 196.85"

Light

Frosted glass globe or reflector spot.
Input Voltage: 110 - 240V
Input Frequency: 50/60Hz
Lumen Output:
Solo: 1500 Lm | Trio: 3 x 1500 Lm | Quintet 5 x 1500 Lm
Color Temperature: 3000K
Color Rendering Index: 90
Diffuser: Glass globe or Reflector spot
Dimming: 1 - 10V or Dali (only for Solo)
CE/CB certified / cULus listed



BuzziSol Globe's light source is housed within a frosted glass globe, which offers 170 degrees of illumination.



BuzziSol Trio and BuzziSol Quintet provide multiple lighting sources without the hassle of numerous bases and power cords.



The spot is concealed inside a powder-coated metal heat sink and is equipped with a 38-degree reflector that allows it to direct light onto a surface.

LUX levels

To light up your space with optimal LUX levels, take the following measurements into account.

Solo Spot

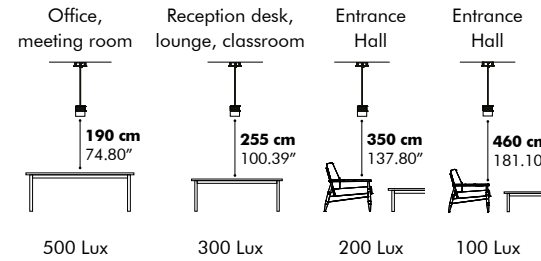

Solo Globe

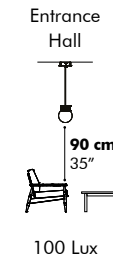

Trio Spot

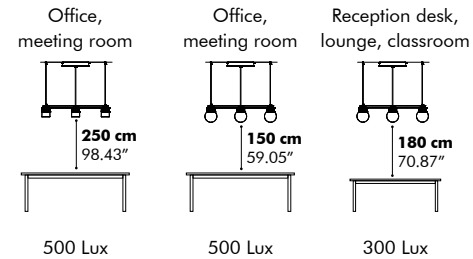

Trio Globe

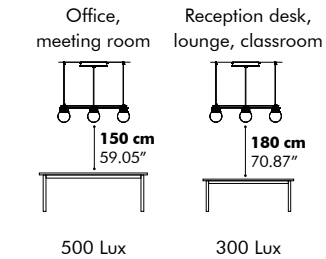

Quintet Spot

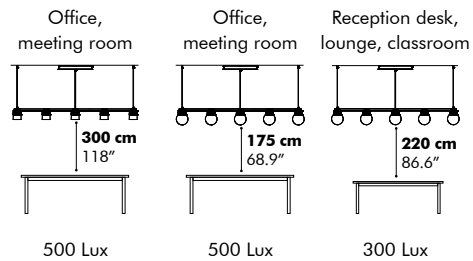

Quintet Globe

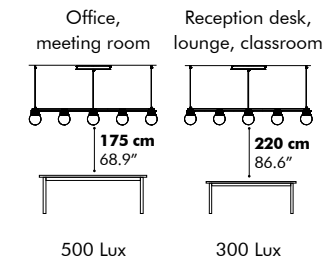

According to EN12464 (only on LUX levels) at full output

How to order

Model, light option, mounting option
(only for Trio and Quintet)

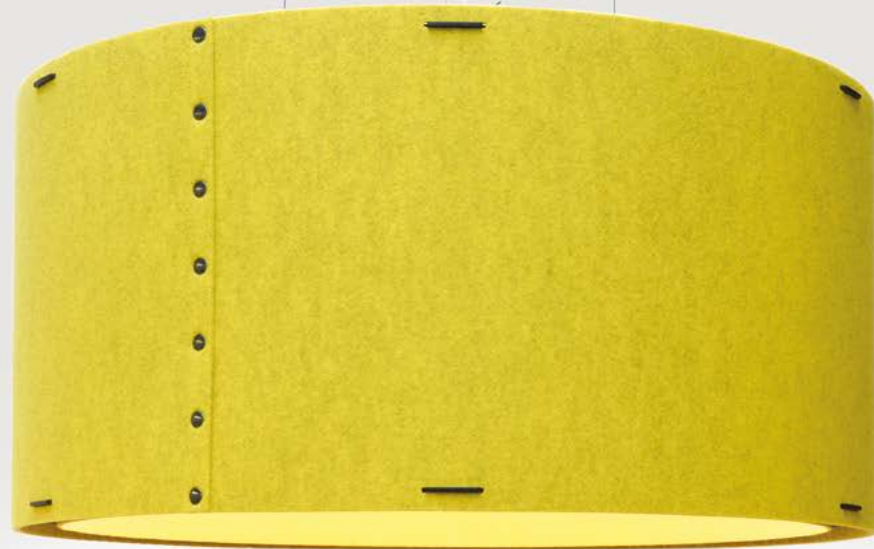

BuzziTrom

— By BuzziSpace Studio

Functional lighting with acoustic abilities

BuzziTrom is our first functional acoustic lighting solution crafted from a dual layer of felt that works on speech and high tones. Its cylindrical design traps sound waves within the radius of its frame; meanwhile, the exterior helps diffuse sound energy.



Models

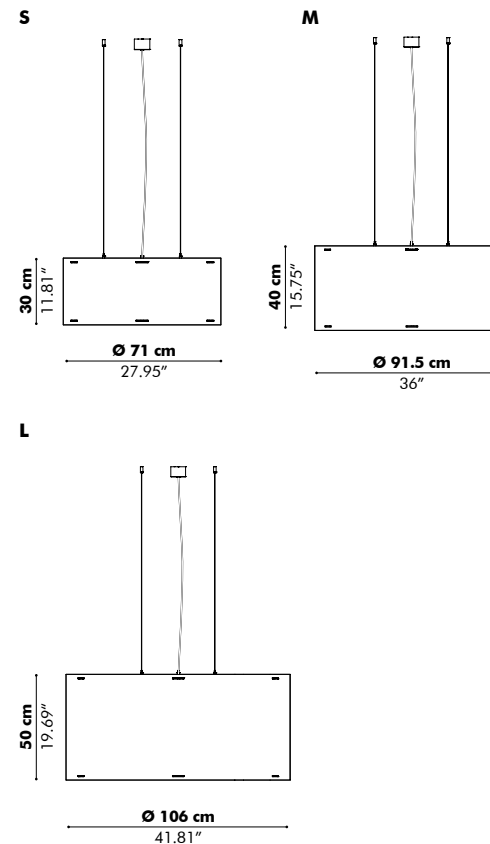

Light

Input Voltage: 230V / 120V
 Input Frequency: 50/60Hz
 Lumen output: 2545 Lm
 Color temperature: 3000K or 4000K (CE/CB)
 Color Rendering Index: >90
 Dimming: 1 - 10V or Dali (CE/CB)
 Diffuser: milky (URG22) or prismatic (UGR19) (CE/CB)
 CE/CB certified / cULus listed

Options

Bicolor (inside or outside in different felt color)

LUX levels

To light up your space with optimal LUX levels, take the following measurements into account.

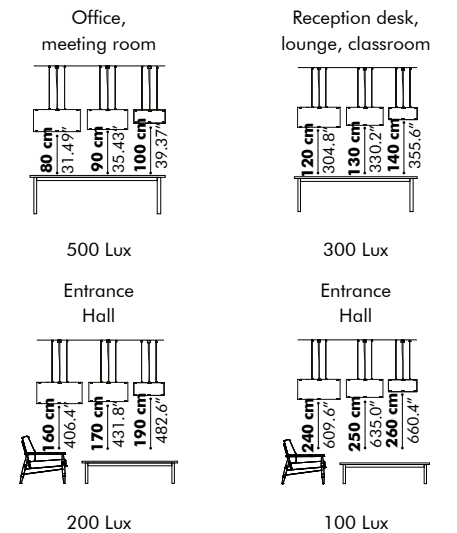

Finishes

Metal frame in black (RAL 9005)
 Shade with an inside and outside layer of BuzziFelt finished with push buttons in glossy black.
 (Check our application overview p. 138)

Mounting

White metal ceiling canopy and transparent power cable incl.

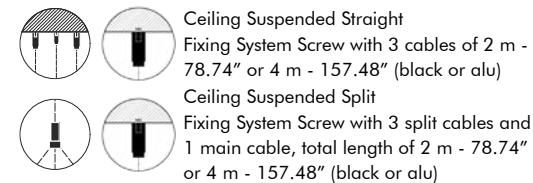



BuzziZepp Light

— By Alain Gilles

A sleek acoustic light

BuzziZepp Light doubles as a sound-absorbing panel and can be paired with either our LED line and both Globe or Spot iterations of BuzziSol Trio and BuzziSol Quintet. This lighting solution additionally ensures your space has minimal echo and adequate lighting.



Models

S

LED Line 113

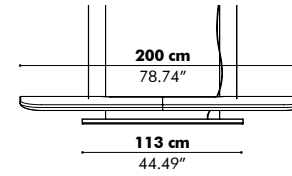

Sol Spot Trio

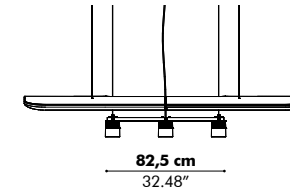

Sol Spot Quintet

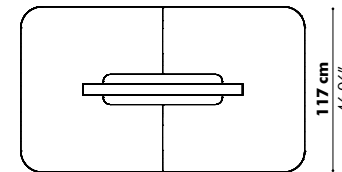
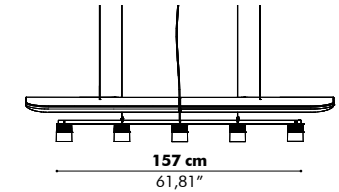

Sol Globe Trio

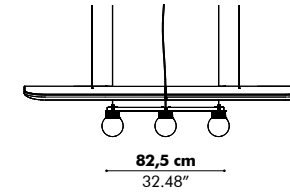

Sol Globe Quintet

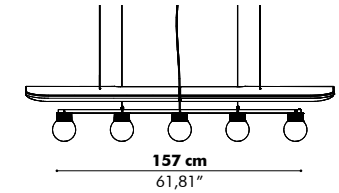

M

LED Line 225

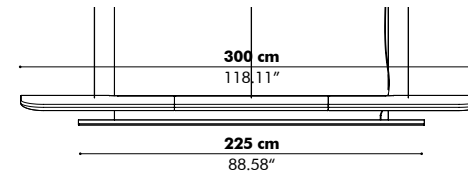

Sol Spot Quintet

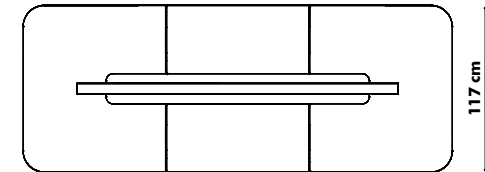
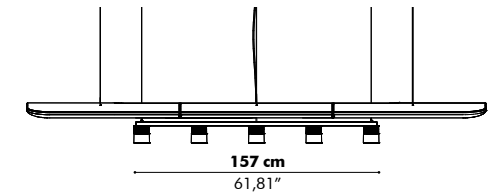

Sol Globe Quintet

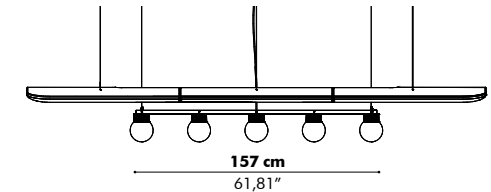



BuzziZepp Light helps to establish private zones for an intimate and more purposeful sense of space.



BuzziZepp Light paired with our LED line.



The acoustic lighting solution doubles as a sound-absorbing panel.

Finishes

Upholstery in fabric collections CAT A, B, C, D, E
 Different Light options available
 (Check our application overview p. 138)

Mounting

Black metal ceiling canopy



Ceiling Suspended
 Fixing System Screw with 6 or 8 cables of 2 m - 78.74" or 5 m - 196.85" (black or alu)

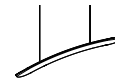

The acoustic panel can be mounted straight or slanted, with a maximum angle of 20° to create a more secluded setting.

Light

Small

LED Line 113 cm
 Output: 2300 Lm
 230V / 120V
 3000K
 1 - 10V

Sol Trio Globe/Spot
 Output: 3 x 1500 Lm
 110 - 240V
 3000K
 1 - 10V

Sol Quintet Globe/Spot
 Output: 5 x 1500 Lm
 110 - 240V
 3000K
 1 - 10V dimming

CE/CB certified / cULus listed

Medium

LED Line 225 cm
 Output: 4600 Lm
 230V / 120V
 3000K
 1 - 10V

Sol Quintet Globe/Spot
 5 x 1500 Lm
 110 - 240V
 3000K
 1 - 10V

CE/CB certified / cULus listed

LUX levels

To light up your space with optimal LUX levels, take the following measurements into account.

LED Line 113

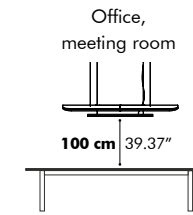

500 Lux

LED Line 225

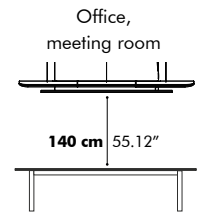

500 Lux

Sol Trio Spot

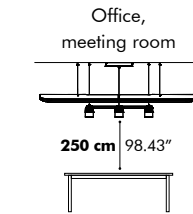

500 Lux

Sol Trio Globe

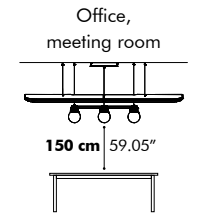

500 Lux

Sol Quintet Spot

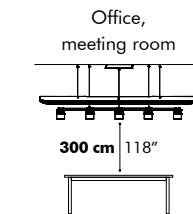

500 Lux

Sol Quintet Globe

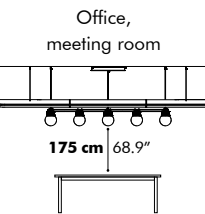

500 Lux

According to EN12464 (only on LUX levels)

How to order

Size
 Fabric (CAT > collection > color)
 Light option
 Mounting option



BuzziLight World

Take a Look Around

Since 2007, our acoustic lighting solutions have helped create happy, healthy, and acoustically balanced workspaces, so it's no wonder they can be found all over the world! Our lighting designs have been incorporated into everything from office spaces, educational settings, the hospitality sector and beyond.

Take a look at some of our favorite projects and installations, and we hope you find inspiration in creating your own Hubs for Togetherness so your employees can thrive.



- 01. BuzziShade | Intive Offices, Wroclaw, PL | Mariola Zolodz
- 02. BuzziLight Mono | Tribal Offices, Montreal, CA | Maxime Brouillet
- 03. BuzziDome | Archiproducts, Milan, IT | Andrea Liverani



- 04.** BuzziJet - BuzziMoon | Bern University, CH | Christine Strub
- 05.** BuzziPleat - BuzziHat | International logistics and distribution company, London, UK | Leon Hargreaves
- 06.** BuzziChandelier | Teeside University Library, Middlesbrough, UK | MHK Photography

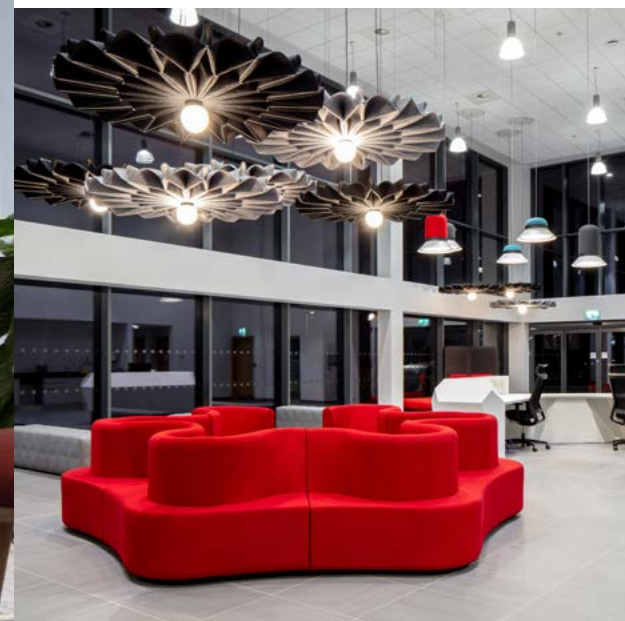

- 07. BuzziJet Standing | Service Express, Grand Rapids, US
- 08. BuzziBell | Technicolor offices, Atlanta, US | Brian Gassel
- 09. BuzziMoon | Finastra Offices, Bucharest, RO | Andrei Tudoran

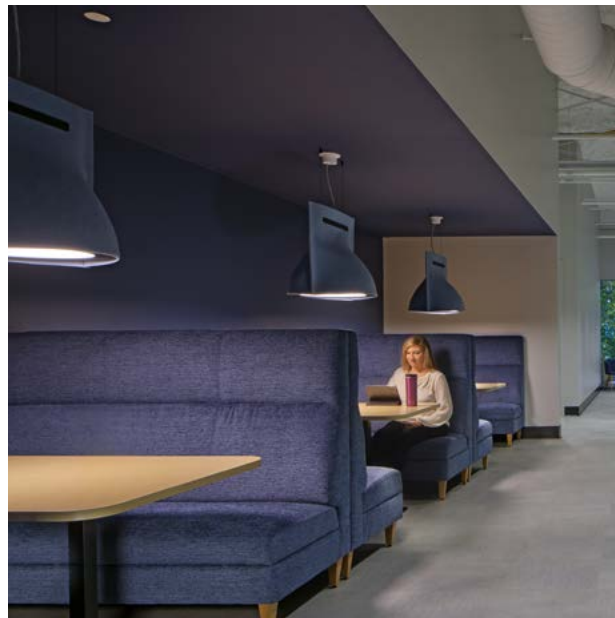



10. BuzziProp | Restaurant Il Luogo di Aimo e Nadia, Milan, IT | Santi Caleca
11. BuzziZepp Light | TechHub, London, UK | Andrea Bartoluccio

Lighting Specifications

- 102** **LED Globe Solo**
- 104 LED Spot Solo
- 106 LED Globe Trio
- 108 LED Spot Trio
- 110 LED Globe Quintet
- 112 LED Spot Quintet
- 114 LED Line 85
- 116 LED Line 125
- 118 LED Line 113
- 120 LED Line 225
- 122 LED Disk Ø 450
- 124 LED Disk Ø 460
- 126 LED Disk Ø 470
- 128 LED Disk Ø 670



APPLICATION OVERVIEW

Lighting Specifications

- Not possible
- Possible

Product	Retrofit	LED Globe			LED Spot			LED Line				LED Disk			
		Solo	Trio	Quintet	Solo	Trio	Quintet	85	113	125	225	Ø 450	Ø 460	Ø 470	Ø 670
BuzziBell	<input type="radio"/>	<input type="radio"/>	<input type="radio"/>	<input type="radio"/>	<input type="radio"/>	<input type="radio"/>	<input type="radio"/>	<input type="radio"/>	<input type="radio"/>	<input type="radio"/>	<input type="radio"/>	<input type="radio"/>	<input type="radio"/>	<input checked="" type="radio"/>	<input type="radio"/>
BuzziChandelier	<input checked="" type="radio"/>	<input type="radio"/>	<input type="radio"/>	<input type="radio"/>	<input type="radio"/>	<input type="radio"/>	<input type="radio"/>	<input type="radio"/>	<input type="radio"/>	<input type="radio"/>	<input type="radio"/>	<input type="radio"/>	<input type="radio"/>	<input type="radio"/>	<input type="radio"/>
BuzziChip															
	S	<input type="radio"/>	<input checked="" type="radio"/>	<input type="radio"/>	<input checked="" type="radio"/>	<input type="radio"/>	<input type="radio"/>	<input type="radio"/>	<input type="radio"/>	<input type="radio"/>	<input type="radio"/>	<input type="radio"/>	<input type="radio"/>	<input type="radio"/>	<input type="radio"/>
	M	<input type="radio"/>	<input type="radio"/>	<input checked="" type="radio"/>	<input type="radio"/>	<input checked="" type="radio"/>	<input type="radio"/>	<input type="radio"/>	<input type="radio"/>	<input type="radio"/>	<input type="radio"/>	<input type="radio"/>	<input type="radio"/>	<input type="radio"/>	<input type="radio"/>
	L	<input type="radio"/>	<input type="radio"/>	<input type="radio"/>	<input checked="" type="radio"/>	<input type="radio"/>	<input checked="" type="radio"/>	<input type="radio"/>	<input type="radio"/>	<input type="radio"/>	<input type="radio"/>	<input type="radio"/>	<input type="radio"/>	<input type="radio"/>	<input type="radio"/>
BuzziCone	<input checked="" type="radio"/>	<input checked="" type="radio"/>	<input type="radio"/>	<input type="radio"/>	<input checked="" type="radio"/>	<input type="radio"/>	<input type="radio"/>	<input type="radio"/>	<input type="radio"/>	<input type="radio"/>	<input type="radio"/>	<input type="radio"/>	<input type="radio"/>	<input type="radio"/>	<input type="radio"/>
BuzziDisk	<input type="radio"/>	<input type="radio"/>	<input type="radio"/>	<input type="radio"/>	<input type="radio"/>	<input type="radio"/>	<input type="radio"/>	<input type="radio"/>	<input type="radio"/>	<input type="radio"/>	<input type="radio"/>	<input checked="" type="radio"/>	<input type="radio"/>	<input type="radio"/>	<input type="radio"/>
BuzziDome	<input type="radio"/>	<input type="radio"/>	<input type="radio"/>	<input type="radio"/>	<input type="radio"/>	<input type="radio"/>	<input type="radio"/>	<input type="radio"/>	<input type="radio"/>	<input type="radio"/>	<input type="radio"/>	<input type="radio"/>	<input type="radio"/>	<input checked="" type="radio"/>	<input type="radio"/>
BuzziHat	<input type="radio"/>	<input type="radio"/>	<input type="radio"/>	<input type="radio"/>	<input type="radio"/>	<input type="radio"/>	<input type="radio"/>	<input type="radio"/>	<input type="radio"/>	<input type="radio"/>	<input type="radio"/>	<input type="radio"/>	<input checked="" type="radio"/>	<input type="radio"/>	<input type="radio"/>
BuzziJet															
	S, M & XL	<input type="radio"/>	<input type="radio"/>	<input type="radio"/>	<input type="radio"/>	<input type="radio"/>	<input type="radio"/>	<input type="radio"/>	<input type="radio"/>	<input type="radio"/>	<input type="radio"/>	<input type="radio"/>	<input type="radio"/>	<input checked="" type="radio"/>	<input type="radio"/>
	XXL	<input type="radio"/>	<input type="radio"/>	<input type="radio"/>	<input type="radio"/>	<input type="radio"/>	<input type="radio"/>	<input type="radio"/>	<input type="radio"/>	<input type="radio"/>	<input type="radio"/>	<input type="radio"/>	<input type="radio"/>	<input type="radio"/>	<input checked="" type="radio"/>
BuzziJet Standing	<input type="radio"/>	<input type="radio"/>	<input type="radio"/>	<input type="radio"/>	<input type="radio"/>	<input type="radio"/>	<input type="radio"/>	<input type="radio"/>	<input type="radio"/>	<input type="radio"/>	<input type="radio"/>	<input type="radio"/>	<input type="radio"/>	<input checked="" type="radio"/>	<input type="radio"/>
BuzziLight Mono	<input checked="" type="radio"/>	<input type="radio"/>	<input type="radio"/>	<input type="radio"/>	<input type="radio"/>	<input type="radio"/>	<input type="radio"/>	<input type="radio"/>	<input type="radio"/>	<input type="radio"/>	<input type="radio"/>	<input type="radio"/>	<input type="radio"/>	<input type="radio"/>	<input type="radio"/>
BuzziMoon	<input type="radio"/>	<input type="radio"/>	<input type="radio"/>	<input type="radio"/>	<input type="radio"/>	<input type="radio"/>	<input type="radio"/>	<input type="radio"/>	<input type="radio"/>	<input type="radio"/>	<input type="radio"/>	<input type="radio"/>	<input type="radio"/>	<input checked="" type="radio"/>	<input type="radio"/>
BuzziPleat Light	<input type="radio"/>	<input checked="" type="radio"/>	<input type="radio"/>	<input type="radio"/>	<input checked="" type="radio"/>	<input type="radio"/>	<input type="radio"/>	<input type="radio"/>	<input type="radio"/>	<input type="radio"/>	<input type="radio"/>	<input type="radio"/>	<input type="radio"/>	<input type="radio"/>	<input type="radio"/>
BuzziProp															
	Small	<input checked="" type="radio"/>	<input checked="" type="radio"/>	<input type="radio"/>	<input checked="" type="radio"/>	<input type="radio"/>	<input type="radio"/>	<input type="radio"/>	<input type="radio"/>	<input type="radio"/>	<input type="radio"/>	<input type="radio"/>	<input type="radio"/>	<input type="radio"/>	<input type="radio"/>
	Beam	<input type="radio"/>	<input type="radio"/>	<input checked="" type="radio"/>	<input type="radio"/>	<input checked="" type="radio"/>	<input type="radio"/>	<input type="radio"/>	<input type="radio"/>	<input type="radio"/>	<input type="radio"/>	<input type="radio"/>	<input type="radio"/>	<input type="radio"/>	<input type="radio"/>
BuzziShade															
	M & L	<input checked="" type="radio"/>	<input checked="" type="radio"/>	<input type="radio"/>	<input checked="" type="radio"/>	<input type="radio"/>	<input type="radio"/>	<input type="radio"/>	<input type="radio"/>	<input type="radio"/>	<input type="radio"/>	<input type="radio"/>	<input type="radio"/>	<input type="radio"/>	<input type="radio"/>
	XL & XXL	<input type="radio"/>	<input type="radio"/>	<input type="radio"/>	<input type="radio"/>	<input type="radio"/>	<input type="radio"/>	<input type="radio"/>	<input type="radio"/>	<input type="radio"/>	<input type="radio"/>	<input type="radio"/>	<input type="radio"/>	<input checked="" type="radio"/>	<input type="radio"/>
BuzziShade Square															
	M	<input checked="" type="radio"/>	<input checked="" type="radio"/>	<input type="radio"/>	<input checked="" type="radio"/>	<input type="radio"/>	<input type="radio"/>	<input type="radio"/>	<input type="radio"/>	<input type="radio"/>	<input type="radio"/>	<input type="radio"/>	<input type="radio"/>	<input type="radio"/>	<input type="radio"/>
	Beam	<input type="radio"/>	<input type="radio"/>	<input type="radio"/>	<input type="radio"/>	<input checked="" type="radio"/>	<input type="radio"/>	<input type="radio"/>	<input type="radio"/>	<input type="radio"/>	<input type="radio"/>	<input type="radio"/>	<input type="radio"/>	<input type="radio"/>	<input type="radio"/>
BuzziShade Standing	<input checked="" type="radio"/>	<input type="radio"/>	<input type="radio"/>	<input type="radio"/>	<input type="radio"/>	<input type="radio"/>	<input type="radio"/>	<input type="radio"/>	<input type="radio"/>	<input type="radio"/>	<input type="radio"/>	<input type="radio"/>	<input type="radio"/>	<input type="radio"/>	<input type="radio"/>
BuzziShield Light															
	S	<input type="radio"/>	<input type="radio"/>	<input type="radio"/>	<input type="radio"/>	<input type="radio"/>	<input type="radio"/>	<input checked="" type="radio"/>	<input type="radio"/>	<input type="radio"/>	<input type="radio"/>	<input type="radio"/>	<input type="radio"/>	<input type="radio"/>	<input type="radio"/>
	M	<input type="radio"/>	<input type="radio"/>	<input type="radio"/>	<input type="radio"/>	<input type="radio"/>	<input type="radio"/>	<input type="radio"/>	<input type="radio"/>	<input checked="" type="radio"/>	<input type="radio"/>	<input type="radio"/>	<input type="radio"/>	<input type="radio"/>	<input type="radio"/>
BuzziSol															
	Solo	<input type="radio"/>	<input checked="" type="radio"/>	<input type="radio"/>	<input checked="" type="radio"/>	<input type="radio"/>	<input type="radio"/>	<input type="radio"/>	<input type="radio"/>	<input type="radio"/>	<input type="radio"/>	<input type="radio"/>	<input type="radio"/>	<input type="radio"/>	<input type="radio"/>
	Trio	<input type="radio"/>	<input type="radio"/>	<input checked="" type="radio"/>	<input type="radio"/>	<input checked="" type="radio"/>	<input type="radio"/>	<input type="radio"/>	<input type="radio"/>	<input type="radio"/>	<input type="radio"/>	<input type="radio"/>	<input type="radio"/>	<input type="radio"/>	<input type="radio"/>
	Quintet	<input type="radio"/>	<input type="radio"/>	<input type="radio"/>	<input checked="" type="radio"/>	<input type="radio"/>	<input checked="" type="radio"/>	<input type="radio"/>	<input type="radio"/>	<input type="radio"/>	<input type="radio"/>	<input type="radio"/>	<input type="radio"/>	<input type="radio"/>	<input type="radio"/>
BuzziTrom	<input type="radio"/>	<input type="radio"/>	<input type="radio"/>	<input type="radio"/>	<input type="radio"/>	<input type="radio"/>	<input type="radio"/>	<input type="radio"/>	<input type="radio"/>	<input type="radio"/>	<input type="radio"/>	<input type="radio"/>	<input type="radio"/>	<input checked="" type="radio"/>	<input type="radio"/>
BuzziZepp Light															
	S	<input type="radio"/>	<input type="radio"/>	<input checked="" type="radio"/>	<input checked="" type="radio"/>	<input type="radio"/>	<input checked="" type="radio"/>	<input checked="" type="radio"/>	<input type="radio"/>	<input type="radio"/>	<input checked="" type="radio"/>	<input type="radio"/>	<input type="radio"/>	<input type="radio"/>	<input type="radio"/>
	M	<input type="radio"/>	<input type="radio"/>	<input type="radio"/>	<input checked="" type="radio"/>	<input type="radio"/>	<input type="radio"/>	<input checked="" type="radio"/>	<input type="radio"/>	<input type="radio"/>	<input checked="" type="radio"/>	<input type="radio"/>	<input type="radio"/>	<input type="radio"/>	<input type="radio"/>

Find the latest update of the application overview on our website: www.buzzi.space

LED Globe Solo

LED Globe Solo

- LED Spot Solo
- LED Globe Trio
- LED Spot Trio
- LED Globe Quintet
- LED Spot Quintet
- LED Line 85
- LED Line 125
- LED Line 113
- LED Line 225
- LED Disk Ø 450
- LED Disk Ø 460
- LED Disk Ø 470
- LED Disk Ø 670

Products

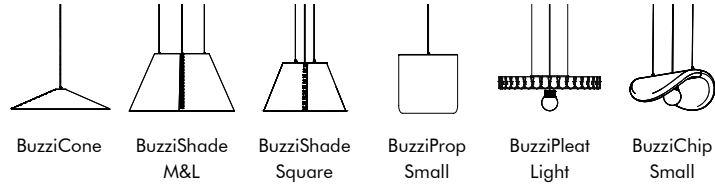

Description

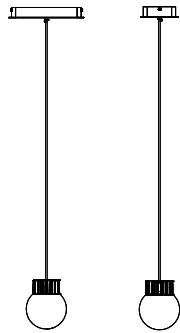

BuzziSpace LED Globe is a suspended LED fixture consisting of a powder-coated black heatsink with a LED chip on board (COB) light source. A frosted glass globe diffuser spreads the light at a large beam angle, lighting up the surroundings or the inside of our upholstered shades.

The LED Globe is offered as a separate light fixture, BuzziSol Globe, or combined or integrated into a shade or acoustic body to make a complete luminaire.

Technical Characteristics

Certification	CE/CB	cULus
Input voltage	220 - 240V	100 - 240/277V
Lamp	1 x LED C.O.B.	1 x LED C.O.B.
Gear / Transfo	LED gear incl.	LED gear incl.
Gear settings	Set at 500mA	Set at 500mA
Luminaire power	32 W	19 W
Color temperature	3000K	3000K
IP	IP20	IP20
Source lifetime	50.000 hrs L70	50.000 hrs L70
CRI	90	90
Lumen output	1500 Lm (LED source)	1500 Lm (LED source)
Efficacy	87 Lm/w	77,5 Lm/w
Dimmability	1 - 10V or Dali (CE/CB)	1 - 10V
UGR	23	23
MacAdam	3 SDCM	3 SDCM
Beam angle	170° (non directional)	170° (non directional)

Photometric Data

Glare evaluation according to UGR											
Room size		70	70	50	50	30	70	70	50	50	30
p Ceiling		50	30	50	30	30	50	30	50	30	30
p Walls		20	20	20	20	20	20	20	20	20	20
p Floor		20	20	20	20	20	20	20	20	20	20
Room size X Y	Viewing direction at right angles to lamp axis					Viewing direction parallel to lamp axis					
	2H	2H	17.4	18.4	18.2	19.2	20.3	17.4	18.4	18.2	19.2
	3H	10.8	20.8	20.7	21.8	22.7	10.8	20.8	20.7	21.8	22.7
	4H	21.1	22.0	22.0	22.9	24.0	21.1	22.0	22.0	22.9	24.0
	6H	22.4	23.3	23.3	24.1	25.2	22.4	23.3	23.3	24.1	25.2
	8H	23.1	23.9	23.9	24.7	25.9	23.1	23.9	23.9	24.7	25.9
	12H	23.7	24.5	24.6	25.4	26.5	23.7	24.5	24.6	25.4	26.5
4H	2H	18.1	19.0	18.9	19.8	20.9	18.1	19.0	18.9	19.8	20.9
	3H	20.7	21.5	21.6	22.4	23.5	20.7	21.5	21.6	22.4	23.5
	4H	22.1	22.8	23.0	23.7	24.9	22.1	22.8	23.0	23.7	24.9
	6H	23.6	24.2	24.5	25.1	26.3	23.6	24.2	24.5	25.1	26.3
	8H	24.3	24.9	25.2	25.8	27.0	24.3	24.9	25.2	25.8	27.0
	12H	25.1	25.8	26.0	26.5	27.7	25.1	25.8	26.0	26.5	27.7
8H	4H	22.6	23.2	23.5	24.1	25.3	22.6	23.2	23.5	24.1	25.3
	6H	24.3	24.7	25.2	25.7	26.9	24.3	24.7	25.2	25.7	26.9
	8H	25.1	25.6	26.1	26.5	27.7	25.1	25.6	26.1	26.5	27.7
	12H	26.0	26.4	27.0	27.4	28.6	26.0	26.4	27.0	27.4	28.6
12H	4H	22.7	23.2	23.6	24.1	25.3	22.7	23.2	23.6	24.1	25.3
	6H	24.4	24.9	25.4	25.8	27.0	24.4	24.9	25.4	25.8	27.0
	8H	25.4	25.8	26.3	26.7	28.0	25.4	25.8	26.3	26.7	28.0

Corrected glare indices referring to 1490lm Total luminous flux
The UGR values are calculated in acc. with CIE Publ. 117. Spacing-to-height ratio = 0.25

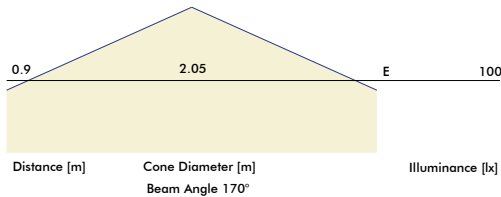
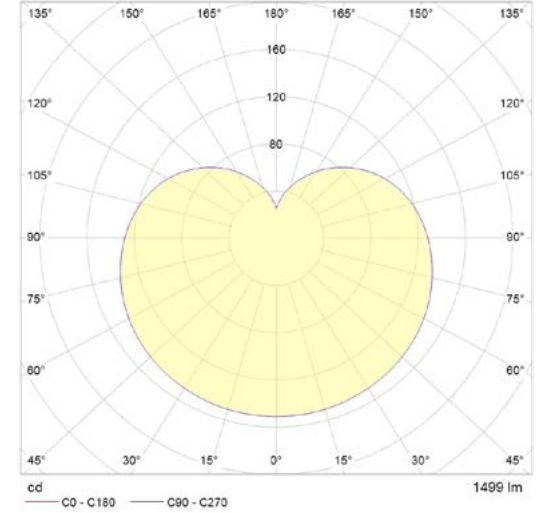

LIGHTING SPECIFICATIONS

LED Globe Solo

LED Spot Solo

LED Globe Trio

LED Spot Trio

LED Globe Quintet

LED Spot Quintet

LED Line 85

LED Line 125

LED Line 113

LED Line 225

LED Disk Ø 450

LED Disk Ø 460

LED Disk Ø 470

LED Disk Ø 670

LED Spot Solo

Products

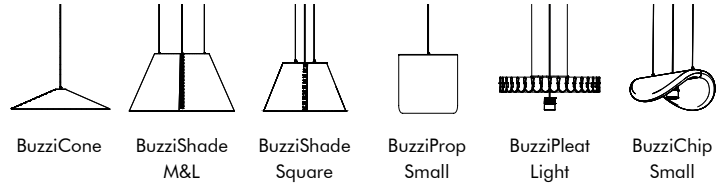

Description

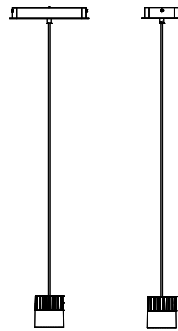

BuzziSpace LED Spot is a suspended LED fixture consisting of a powder-coated black heatsink with a LED chip on board (COB) light source. A reflector spot adaptor directs the light with a beam angle of 38° downwards.

The LED Spot is offered as a separate light fixture, BuzziSol Spot, or combined or integrated into a shade or acoustic body to make a complete luminaire.

Technical Characteristics

Certification	CE/CB	cULus
Input voltage	220 - 240V	100 - 240/277V
Lamp	1 x LED C.O.B.	1 x LED C.O.B.
Gear / Transfo	LED gear incl.	LED gear incl.
Gear settings	Set at 500mA	Set at 500mA
Luminaire power	32 W	32 W
Color temperature	3000K	3000K
IP	IP20	IP20
Source lifetime	50.000 hrs L70	50.000 hrs L70
CRI	90	90
Lumen output	1500 Lm (LED source)	1500 Lm (LED source)
Efficacy	47,8 Lm/w	77,5 Lm/w
Dimmability	1 - 10V or Dali	1 - 10V
UGR	12	12
MacAdam	3 SDCM	3 SDCM
Beam angle	38° (reflector)	38° (reflector)

Photometric Data

Glare evaluation according to UGR											
Room size		Viewing direction at right angles to lamp axis					Viewing direction parallel to lamp axis				
X	Y	20	30	40	50	60	70	80	90	100	110
p Ceiling		70	70	50	50	30	70	70	50	50	30
p Walls		60	30	60	30	30	60	30	60	30	30
p Floor		20	20	20	20	20	20	20	20	20	20
2H	2H	11,3	12,0	11,8	12,2	12,4	11,3	11,8	11,5	12,1	12,4
	3H	11,3	11,9	11,8	12,1	12,4	11,3	11,8	11,8	12,1	12,4
	4H	11,3	11,8	11,8	12,1	12,4	11,3	11,8	11,8	12,1	12,4
	6H	11,3	11,8	11,8	12,1	12,4	11,3	11,8	11,8	12,1	12,4
	8H	11,2	11,7	11,8	12,0	12,3	11,2	11,7	11,8	12,0	12,3
	12H	11,2	11,7	11,8	12,0	12,3	11,2	11,7	11,8	12,0	12,3
4H	2H	11,2	11,7	11,5	12,0	12,2	11,2	11,7	11,5	12,0	12,2
	3H	11,2	11,7	11,5	12,0	12,3	11,2	11,6	11,5	12,0	12,3
	4H	11,2	11,6	11,6	12,0	12,3	11,2	11,6	11,6	11,9	12,3
	6H	11,2	11,6	11,8	11,0	12,3	11,2	11,6	11,8	11,0	12,3
	8H	11,2	11,5	11,8	11,9	12,3	11,2	11,5	11,8	11,9	12,3
	12H	11,2	11,5	11,8	11,9	12,3	11,2	11,4	11,8	11,9	12,3
0H	4H	11,1	11,4	11,8	11,0	12,2	11,1	11,4	11,8	11,0	12,2
	6H	11,2	11,4	11,8	11,8	12,3	11,2	11,4	11,8	11,8	12,3
	8H	11,2	11,3	11,8	11,8	12,3	11,2	11,3	11,8	11,8	12,3
	12H	11,2	11,3	11,8	11,8	12,3	11,1	11,3	11,8	11,8	12,3
12H	4H	11,1	11,4	11,5	11,8	12,2	11,1	11,4	11,5	11,8	12,2
	6H	11,1	11,3	11,8	11,8	12,2	11,1	11,3	11,8	11,8	12,2
	8H	11,1	11,3	11,0	11,8	12,3	11,1	11,3	11,0	11,7	12,3

Variation of the observer position for the luminaire distances S

S = 1,0H	+5,0 / -5,0	+5,0 / -5,0
S = 1,5H	+8,6 / -5,5	+8,6 / -5,5
S = 2,0H	+10,5 / -5,1	+10,5 / -5,1

Standard table: AK00

Correction Summand: -7,1

Corrected glare indices referring to 1412lm Total luminous flux

The UGR values are calculated in acc. with CIE Publ. 117. Spacing-to-height ratio = 0.25

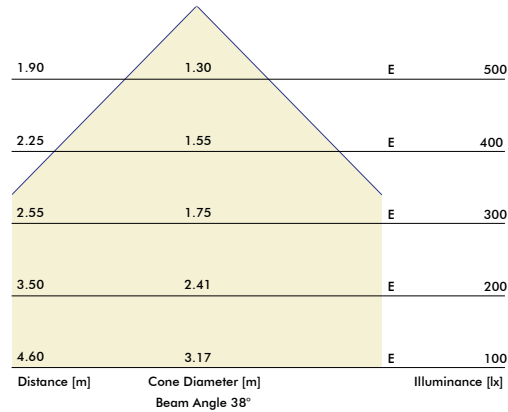
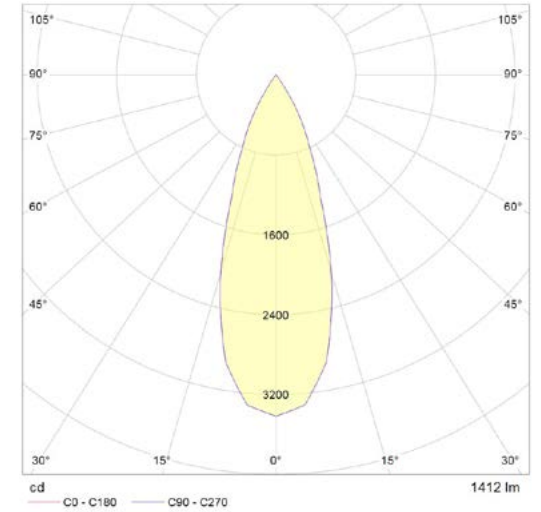

LIGHTING SPECIFICATIONS

- LED Globe Solo
- LED Spot Solo
- LED Globe Trio**
- LED Spot Trio
- LED Globe Quintet
- LED Spot Quintet
- LED Line 85
- LED Line 125
- LED Line 113
- LED Line 225
- LED Disk Ø 450
- LED Disk Ø 460
- LED Disk Ø 470
- LED Disk Ø 670

LED Globe Trio

Products

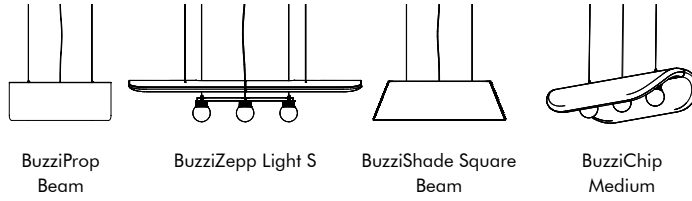

Description

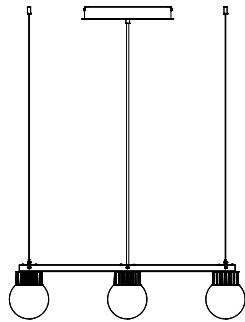

BuzziSpace LED Globe Trio is a suspended LED fixture consisting of three powder-coated black heatsinks with a LED chip on board (COB) light source. Three frosted glass globe diffusers spread the light at a large beam angle, lighting up the surroundings or the inside of our upholstered shades.

LED Globe Trio is offered as a separate light fixture, BuzziSol Trio Globe, or combined or integrated into a shade or acoustic body to make a complete luminaire.

Technical Characteristics

Certification	CE/CB	cULus
Input voltage	220 - 240V	100 - 240/277V
Lamp	3 x LED C.O.B.	3 x LED C.O.B.
Gear / Transfo	LED gear incl.	LED gear incl.
Gear settings	Set at 1450mA	Set at 1450mA
Luminaire power	3 x 16,3 W	60 W
Color temperature	3000K	3000K
IP	IP20	IP20
Source lifetime	50.000 hrs L70	50.000 hrs L70
CRI	90	90
Lumen output	3 x 1500 Lm (LED source)	3 x 1500 Lm (LED source)
Efficacy	92 Lm/w	75 Lm/w
Dimmability	1 - 10V	1 - 10V
UGR	23	23
MacAdam	3 SDCM	3 SDCM
Beam angle	170° (non directional)	170° (non directional)

Photometric Data

Test: 0:230.04V I:0.2356A P:52.219W PF:0.9436 Freq:50.00Hz Lamp Flux:4373.83lx 1m									
NAME: BuzziSol Trio with Globe					TYPE: LED		WEIGHT: N/A		
SPEC.: N/A					DIM.:		SERIAL No.: N/A		
MFR.:					SQR.:		Shielding Angle: N/A		
ceiling/cavity	0.7	0.7	0.5	0.5	0.3	0.7	0.7	0.5	0.5
walls	0.5	0.3	0.5	0.3	0.3	0.5	0.3	0.5	0.3
working plane	0.2	0.2	0.2	0.2	0.2	0.2	0.2	0.2	0.2
Room dimensions					Viewed crosswise		Viewed endwise		
x = 2H	y = 2H	26.4	27.6	27.0	28.3	29.2	26.4	27.7	27.1
3H	29.5	30.6	30.2	31.4	32.3	29.5	30.7	30.2	31.4
4H	31.2	32.3	31.9	33.1	34.0	31.1	32.2	31.8	32.9
6H	33.1	34.2	33.9	35.0	35.9	32.5	33.6	33.3	34.3
8H	34.2	35.2	35.0	36.0	36.9	33.2	34.2	34.0	35.0
12H	35.4	36.4	36.2	37.2	38.2	33.9	34.9	34.6	35.6
4H	2H	27.3	28.4	28.1	29.2	30.1	27.4	28.5	28.1
3H	30.6	31.6	31.3	32.3	33.3	30.6	31.6	31.4	32.4
4H	32.5	33.4	33.2	34.2	35.1	32.4	33.3	33.2	34.1
6H	34.5	35.4	35.4	36.2	37.2	34.1	34.9	34.9	35.7
8H	35.7	36.5	36.5	37.3	38.3	34.9	35.7	35.8	36.5
12H	37.1	37.8	37.9	38.6	39.6	35.8	36.5	36.6	37.3
6H	4H	33.2	33.9	34.0	34.8	35.8	33.1	33.9	33.9
8H	35.0	36.2	36.4	37.0	38.1	35.2	35.9	36.1	36.7
8H	36.9	37.5	37.7	38.3	39.4	36.4	36.9	37.2	37.8
12H	38.4	38.9	39.3	39.8	40.9	37.5	38.0	38.4	38.9
12H	4H	33.4	34.1	34.2	34.9	36.0	33.3	34.0	34.1
6H	35.8	36.4	36.7	37.3	38.4	35.6	36.2	36.4	37.0
8H	37.3	37.8	38.2	38.7	39.8	36.9	37.4	37.7	38.3
Variations with the observer position at spacings:									
s = 1.0H	+ 0.1 / - 0.1					+ 0.1 / - 0.1			
1.5H	+ 0.2 / - 0.3					+ 0.2 / - 0.3			
2.0H	+ 0.3 / - 0.4					+ 0.3 / - 0.4			

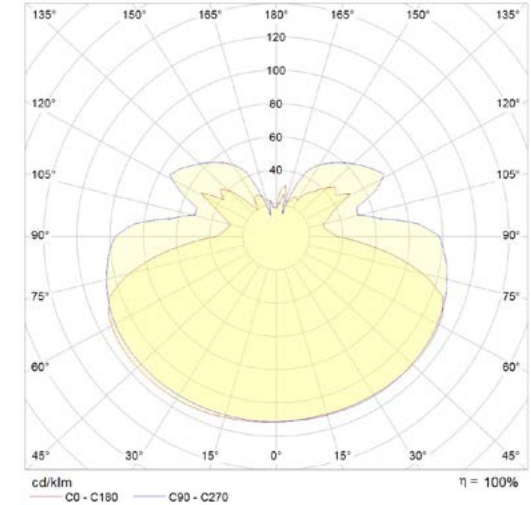
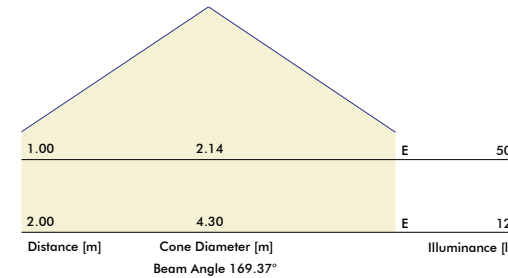

LIGHTING SPECIFICATIONS

- LED Globe Solo
- LED Spot Solo
- LED Globe Trio
- LED Spot Trio**
- LED Globe Quintet
- LED Spot Quintet
- LED Line 85
- LED Line 125
- LED Line 113
- LED Line 225
- LED Disk Ø 450
- LED Disk Ø 460
- LED Disk Ø 470
- LED Disk Ø 670

LED Spot Trio

Products

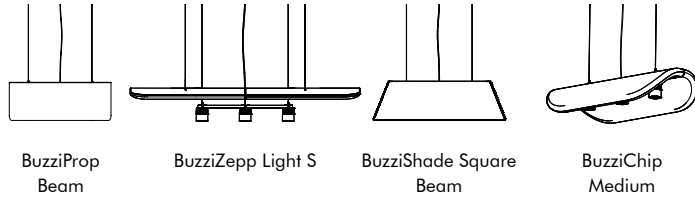

Description

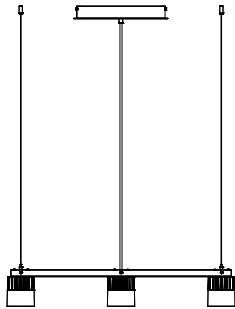

BuzziSpace LED Spot Trio is a suspended LED fixture consisting of three powder-coated black heat sinks with a LED chip on board (COB) light source. Three reflector spots direct the light downwards.

Led Spot Trio is offered as a separate light fixture, BuzziSol Trio Globe, or combined or integrated into a shade or acoustic body to make a complete luminaire.

Technical Characteristics

Certification	CE/CB	cULus
Input voltage	220 - 240V	100 - 240/277V
Lamp	3 x LED C.O.B.	3 x LED C.O.B.
Gear / Transfo	LED gear incl.	LED gear incl.
Gear settings	Set at 1450mA	Set at 1450mA
Luminaire power	3 x 16,3 W	40 W
Color temperature	3000K	3000K
IP	IP20	IP20
Source lifetime	50.000 hrs L70	50.000 hrs L70
CRI	90	90
Lumen output	3 x 1500 Lm (LED source)	3 x 1500 Lm (LED source)
Efficacy	92 Lm/w	75 Lm/w
Dimmability	1 - 10V	1 - 10V
UGR	12	12
MacAdam	3 SDCM	3 SDCM
Beam angle	38°	38°

Photometric Data

Test: 0:230.02V I:0.2355A P:52.193W PF:0.9436 Freq:50.01Hz Lamp Flux:3242.28lm 3m											
NAME: BuzziSol Trio with Spot					TYPE: LED		WEIGHT: N/A				
SPEC.: N/A					DIM.:		SERIAL No.: N/A				
MPN.:					SUB.:		Shielding Angle: M/A				
ceiling/cavity	0.7	0.7	0.5	0.5	0.3	0.7	0.7	0.5	0.5	0.3	
walls	0.5	0.3	0.5	0.3	0.3	0.5	0.3	0.5	0.3	0.3	
working plane	0.2	0.2	0.2	0.2	0.2	0.2	0.2	0.2	0.2	0.2	
Room dimensions											
Viewed crosswise											
x = 2H	y = 2H	11.9	12.6	12.1	12.8	12.9	12.3	13.1	12.5	13.2	13.4
3H	12.1	12.8	12.4	13.0	13.2	12.6	13.3	12.8	13.5	13.7	
4H	12.3	13.0	12.6	13.2	13.4	12.7	13.4	13.0	13.6	13.8	
6H	12.4	13.0	12.7	13.3	13.5	12.9	13.5	13.1	13.7	14.0	
8H	12.5	13.1	12.8	13.3	13.6	12.9	13.5	13.2	13.8	14.0	
12H	12.5	13.1	12.8	13.4	13.6	13.0	13.5	13.3	13.8	14.1	
Viewed endwise											
2H	11.9	12.6	12.2	12.8	13.0	12.3	13.0	12.6	13.2	13.4	
3H	12.3	12.9	12.6	13.2	13.4	12.7	13.3	13.0	13.6	13.8	
4H	12.5	13.1	12.9	13.4	13.7	12.9	13.5	13.3	13.8	14.1	
6H	12.8	13.3	13.2	13.6	13.9	13.2	13.6	13.6	14.0	14.3	
8H	12.9	13.3	13.3	13.7	14.1	13.3	13.7	13.7	14.1	14.4	
12H	13.0	13.4	13.4	13.7	14.1	13.4	13.8	13.8	14.1	14.5	
Variations with the observer position at spacings:											
s = 1.0H	+ 0.4 / - 0.5					+ 0.4 / - 0.5					
1.5H	+ 0.6 / - 0.4					+ 0.6 / - 0.4					
2.0H	+ 0.6 / - 0.5					+ 0.6 / - 0.5					

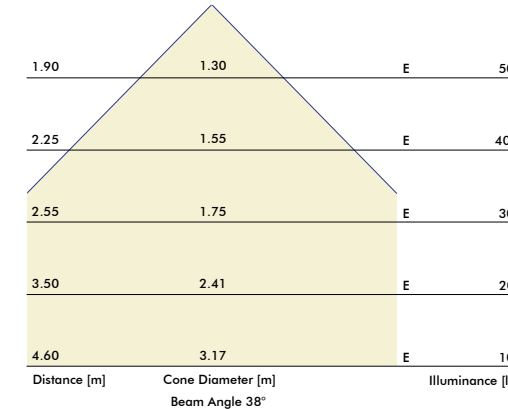
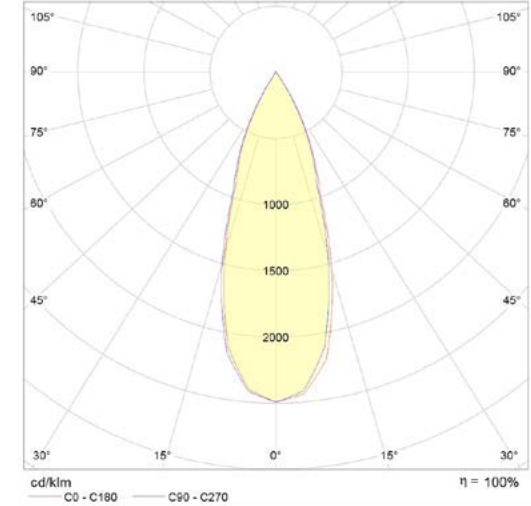

* Per light source

LIGHTING SPECIFICATIONS

LED Globe Solo

LED Spot Solo

LED Globe Trio

LED Spot Trio

LED Globe Quintet

LED Spot Quintet

LED Line 85

LED Line 125

LED Line 113

LED Line 225

LED Disk Ø 450

LED Disk Ø 460

LED Disk Ø 470

LED Disk Ø 670

LED Globe Quintet

Products

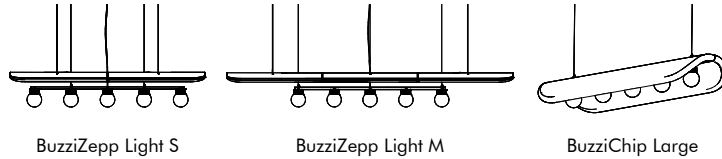

Description

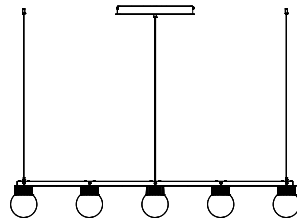

BuzziSpace LED Globe Quintet is a suspended LED fixture consisting of five powder-coated black heatsinks with a LED chip on board (COB) light source. Five frosted glass globe diffusers spread the light at a large beam angle, lighting up the surroundings or the inside of our upholstered shades.

LED Globe Quintet is offered as a separate light fixture, BuzziSol Quintet Globe, or combined or integrated into a shade or acoustic body to make a complete luminaire.

Technical Characteristics

Certification	CE/CB	cULus
Input voltage	220 - 240V	100 - 240/277V
Lamp	5 x LED C.O.B.	5 x LED C.O.B.
Gear / Transfo	LED gear incl.	LED gear incl.
Gear settings	Set at 2450mA	Set at 2450mA
Luminaire power	5 x 16,3 W	90 W
Color temperature	3000K	3000K
IP	IP20	IP20
Source lifetime	50.000 hrs L70	50.000 hrs L70
CRI	90	90
Lumen output	5 x 1500 Lm (LED source)	5 x 1500 Lm (LED source)
Efficacy	92 Lm/w	83 Lm/w
Dimmability	1 - 10V	1 - 10V
UGR	23	23
MacAdam	3 SDCM	3 SDCM
Beam angle	170° (non directional)	170° (non directional)

Photometric Data*

Glare evaluation according to UGR											
Room size		70	70	50	50	30	70	70	50	50	30
p Ceiling		50	30	50	30	30	50	30	50	30	30
p Walls		20	20	20	20	20	20	20	20	20	20
p Floor											
Viewing direction at right angles to lamp axis	Room size										
	X Y										
2H	2H	17.4	18.4	18.2	19.2	20.3	17.4	18.4	18.2	19.2	20.3
	3H	10.8	20.8	20.7	21.8	22.7	10.8	20.8	20.7	21.8	22.7
	4H	21.1	22.0	22.0	22.9	24.0	21.1	22.0	22.0	22.9	24.0
	6H	22.4	23.3	23.3	24.1	25.2	22.4	23.3	23.3	24.1	25.2
	8H	23.1	23.9	23.9	24.7	25.9	23.1	23.9	23.9	24.7	25.9
12H	23.7	24.5	24.6	25.4	26.5	23.7	24.5	24.6	25.4	26.5	
4H	2H	18.1	19.0	18.9	19.8	20.9	18.1	19.0	18.9	19.8	20.9
	3H	20.7	21.5	21.6	22.4	23.5	20.7	21.5	21.6	22.4	23.5
	4H	22.1	22.8	23.0	23.7	24.9	22.1	22.8	23.0	23.7	24.9
	6H	23.6	24.2	24.5	25.1	26.3	23.6	24.2	24.5	25.1	26.3
	8H	24.3	24.9	25.2	25.8	27.0	24.3	24.9	25.2	25.8	27.0
12H	25.1	25.8	26.0	26.5	27.7	25.1	25.8	26.0	26.5	27.7	
8H	4H	22.6	23.2	23.5	24.1	25.3	22.6	23.2	23.5	24.1	25.3
	6H	24.3	24.7	25.2	25.7	26.9	24.3	24.7	25.2	25.7	26.9
	8H	25.1	25.6	26.1	26.5	27.7	25.1	25.6	26.1	26.5	27.7
	12H	26.0	26.4	27.0	27.4	28.6	26.0	26.4	27.0	27.4	28.6
	2H	22.7	23.2	23.6	24.1	25.3	22.7	23.2	23.6	24.1	25.3
6H	24.4	24.9	25.4	25.8	27.0	24.4	24.9	25.4	25.8	27.0	
8H	25.4	25.8	26.3	26.7	28.0	25.4	25.8	26.3	26.7	28.0	
Variation of the observer position for the luminaire distances 5											
S = 1.0H		+0.1 / 0.1				-0.1 / 0.1					
S = 1.5H		+0.2 / -0.2				+0.2 / -0.2					
S = 2.0H		+0.3 / -0.3				+0.3 / -0.3					
Standard table		BK11				BK11					
Correction Summand		10.7				10.7					

Corrected glare indices referring to 1499lm Total luminous flux
The UGR values are calculated in acc. with CIE Publ. 117. Spacing-to-height ratio = 0.25

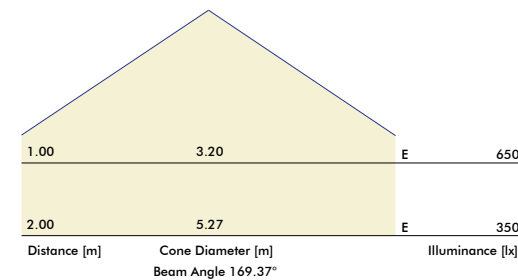
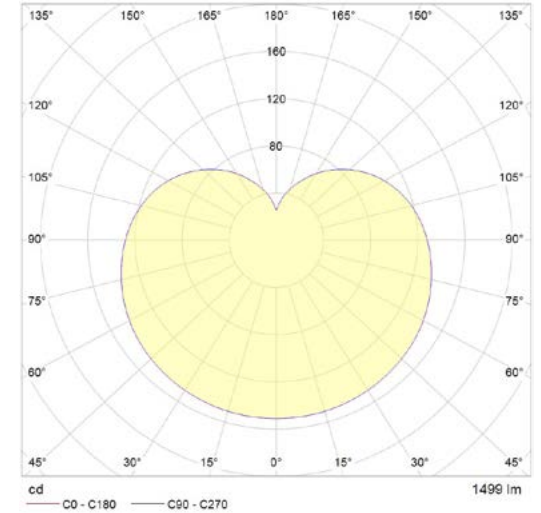

* Per light source

LIGHTING SPECIFICATIONS

- LED Globe Solo
- LED Spot Solo
- LED Globe Trio
- LED Spot Trio
- LED Globe Quintet

LED Spot Quintet

- LED Line 85
- LED Line 125
- LED Line 113
- LED Line 225
- LED Disk Ø 450
- LED Disk Ø 460
- LED Disk Ø 470
- LED Disk Ø 670

LED Spot Quintet

Products

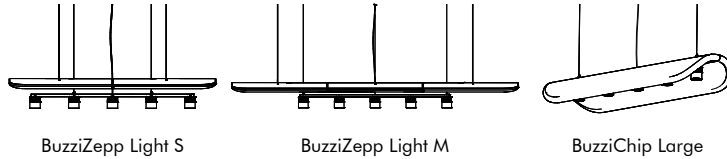

Description

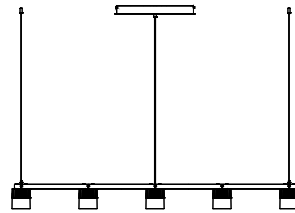

BuzziSpace LED Spot Quintet is a suspended LED fixture consisting of three powder-coated black heatsinks with a LED chip on board (COB) light source. Five frosted glass globe diffuser spreads the light at a large beam angle, lighting up the surroundings or the inside of our upholstered shades.

LED Spot Quintet is offered as a separate light fixture, BuzziSol Quintet Globe, or combined or integrated into a shade or acoustic body to make a complete luminaire.

Technical Characteristics

Certification	CE/CB	cULus
Input voltage	220 - 240V	100 - 240/277V
Lamp	5 x LED C.O.B.	5 x LED C.O.B.
Gear / Transfo	LED gear incl.	LED gear incl.
Gear settings	Set at 2450mA	Set at 2450mA
Luminaire power	5 x 16,3 W	90 W
Color temperature	3000K	3000K
IP	IP20	IP20
Source lifetime	50.000 hrs L70	50.000 hrs L70
CRI	90	90
Lumen output	5 x 1500 Lm (LED source)	5 x 1500 Lm (LED source)
Efficacy	92 Lm/w	83 Lm/w
Dimmability	1 - 10V	1 - 10V
UGR	12	12
MacAdam	3 SDCM	3 SDCM
Beam angle	38°	38°

Photometric Data

Test: 0:229.88V I:0.3874A P:86.910W PF:0.9758 Freq:50.00Hz Lamp Flux:5273.86lm 3m											
NAME: BuzziSol Quintet with Spot					TYPE: LED		WEIGHT: N/A				
SPEC.: N/A					DIM.:		SERIAL No.: N/A				
MFR.:					SQR.:		Shielding Angle: M/A				
ceiling/cavity	0.7	0.7	0.5	0.5	0.3	0.7	0.7	0.5	0.5	0.3	
walls	0.5	0.3	0.5	0.3	0.3	0.5	0.3	0.5	0.3	0.3	
working plane	0.2	0.2	0.2	0.2	0.2	0.2	0.2	0.2	0.2	0.2	
Room dimensions	Viewed crosswise					Viewed endwise					
x = 2H	y = 2H	z = 2H	x = 2H	y = 2H	z = 2H	x = 2H	y = 2H	z = 2H	x = 2H	y = 2H	z = 2H
3H	13.6	14.4	13.8	14.5	14.7	14.5	15.3	14.7	15.4	15.6	15.6
4H	13.9	14.6	14.1	14.8	15.0	14.7	15.4	15.0	15.6	15.8	15.8
6H	14.0	14.7	14.3	14.9	15.1	14.8	15.5	15.1	15.7	15.9	15.9
8H	14.1	14.7	14.4	15.0	15.2	14.9	15.5	15.2	15.8	16.0	16.0
12H	14.2	14.8	14.5	15.0	15.3	14.9	15.5	15.2	15.8	16.1	16.1
4H	2H	13.6	14.3	13.9	14.5	14.7	14.5	15.1	14.7	15.4	15.6
3H	14.0	14.6	14.3	14.9	15.1	14.8	15.4	15.1	15.6	15.9	15.9
4H	14.2	14.8	14.6	15.1	15.4	14.9	15.5	15.3	15.8	16.1	16.1
6H	14.4	14.9	14.8	15.2	15.6	15.1	15.6	15.5	15.9	16.3	16.3
8H	14.5	15.0	14.9	15.3	15.7	15.2	15.6	15.6	16.0	16.4	16.4
12H	14.6	15.0	15.0	15.4	15.8	15.2	15.6	15.7	16.0	16.4	16.4
6H	4H	14.3	14.7	14.7	15.0	15.4	14.9	15.4	15.3	15.7	16.1
6H	14.6	14.9	15.0	15.3	15.7	15.2	15.6	15.6	16.0	16.4	16.4
8H	14.7	15.1	15.2	15.5	15.9	15.3	15.7	15.6	16.1	16.5	16.5
12H	14.8	15.1	15.3	15.6	16.0	15.4	15.7	15.9	16.2	16.6	16.6
12H	4H	14.2	14.6	14.6	15.0	15.4	14.9	15.3	15.3	15.7	16.1
6H	14.6	14.9	15.0	15.3	15.8	15.2	15.5	15.6	15.9	16.4	16.4
8H	14.8	15.1	15.2	15.5	16.0	15.4	15.6	15.8	16.1	16.6	16.6
Variations with the observer position at spacings:											
s = 1.0H	+ 0.4 / - 0.6					+ 0.3 / - 0.6					
1.5H	+ 0.6 / - 0.4					+ 0.9 / - 0.5					
2.0H	+ 0.5 / - 0.6					+ 0.8 / - 0.6					

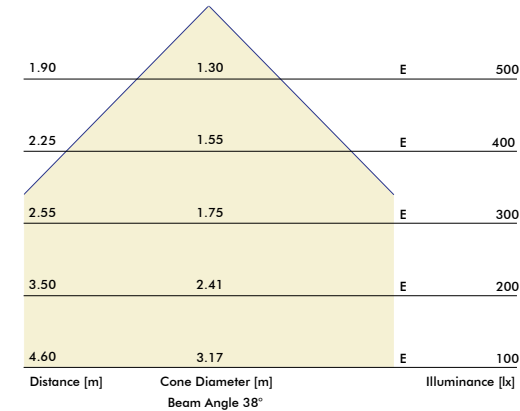
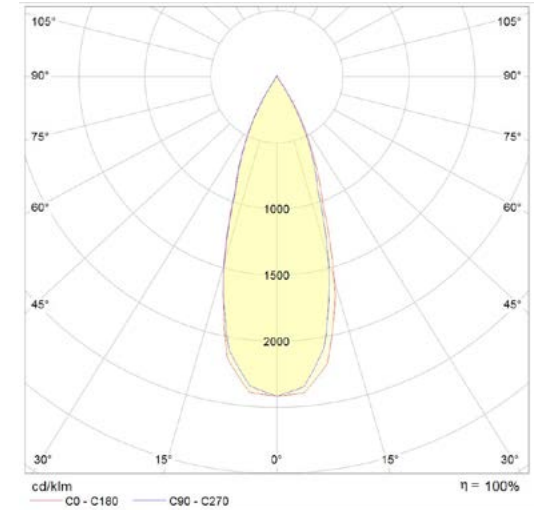

* Per light source

LIGHTING SPECIFICATIONS

- LED Globe Solo
- LED Spot Solo
- LED Globe Trio
- LED Spot Trio
- LED Globe Quintet
- LED Spot Quintet
- LED Line 85**
- LED Line 125
- LED Line 113
- LED Line 225
- LED Disk Ø 450
- LED Disk Ø 460
- LED Disk Ø 470
- LED Disk Ø 670

LED Line 85

Products

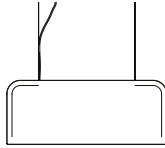

BuzziShield Light M

Description

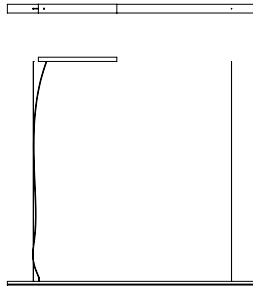

BuzziSpace LED Line 85 is a LED profile for continuous direct lighting. The unit consists of a powder-coated white profile finished with a polycarbonate diffuser. The light source is a LED strip made to fit the size of the LED line 85.

Technical Characteristics

Certification	CE/CB	cULus
Input voltage	220 - 240V	110 - 120V / 277V
Lamp	1 x LED strip	1 x LED strip
Gear / Transfo	LEDGear incl	LED Gear incl
Gear settings	24V	24V
Luminaire power	12 W	15 W
Color temperature	3000K	3000K
IP	IP20	IP20
Source lifetime	50000hr	50000hr
CRI	90	90
Lumen output	960 Lm	960 Lm
Efficacy	80 Lm/w	64 Lm/w
Dimmability	0-10V or DALI	0-10V or DALI
UGR	22	22
MacAdam	5 SDCM	5 SDCM
Beam Angle	112,8°	112,8°

Photometric Data

Glare evaluation according to UGR											
μ Ceiling		70	70	50	50	30	70	70	50	50	30
μ Walls		50	30	50	30	30	50	30	50	30	30
μ Floor		20	20	20	20	20	20	20	20	20	20
Room size X Y		Viewing direction at right angles to lamp axis					Viewing direction parallel to lamp axis				
2H	2H	21.5	22.8	21.8	23.1	23.3	21.5	22.9	21.8	23.1	23.4
	3H	23.0	24.2	23.3	24.5	24.8	23.1	24.3	23.4	24.6	24.9
	4H	23.6	24.8	24.0	25.1	25.4	23.7	24.9	24.1	25.2	25.5
	6H	24.0	25.1	24.4	25.4	25.7	24.2	25.2	24.5	25.6	25.9
	8H	24.2	25.2	24.5	25.5	25.8	24.3	25.4	24.7	25.7	26.0
12H	24.2	25.2	24.6	25.6	25.9	24.4	25.4	24.8	25.7	26.1	
4H	2H	22.2	23.3	22.5	23.6	23.9	22.2	23.4	22.5	23.6	23.9
	3H	23.9	24.9	24.3	25.2	25.5	23.9	24.9	24.3	25.3	25.6
	4H	24.6	25.5	25.0	25.9	26.2	24.7	25.6	25.1	25.9	26.3
	6H	25.1	25.9	25.6	26.3	26.7	25.3	26.0	25.7	26.4	26.8
	8H	25.3	26.0	25.8	26.4	26.9	25.5	26.2	25.9	26.6	27.0
12H	25.4	26.1	25.9	26.5	26.9	25.6	26.3	26.0	26.7	27.1	
8H	4H	24.0	25.6	25.3	26.0	26.4	25.0	25.7	26.4	26.1	26.5
	6H	25.6	26.2	26.0	26.6	27.1	25.7	26.3	26.1	26.7	27.2
	8H	25.9	26.4	26.3	26.8	27.3	26.0	26.5	26.4	26.9	27.4
	12H	26.0	26.4	26.5	26.9	27.4	26.2	26.6	26.7	27.1	27.6
	4H	24.9	25.8	25.4	26.0	26.4	25.0	25.7	25.4	26.1	26.5
6H	25.6	26.2	26.1	26.6	27.1	25.7	26.3	26.2	26.7	27.2	
8H	25.9	26.4	26.4	26.8	27.3	26.1	26.5	26.6	27.0	27.5	
Variation of the observer position for the luminaire distances G											
S = 1.0H		+0.1 / -0.1					+0.1 / -0.1				
S = 1.5H		+0.2 / -0.4					+0.2 / -0.3				
S = 2.0H		+0.4 / -0.7					+0.4 / -0.6				
Standard table		BK06					BK06				
Correction Dimmnd		8.7					8.8				
Corrected glare indices referring to 90lm Total luminous flux											

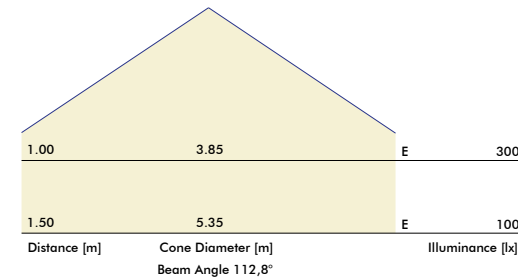
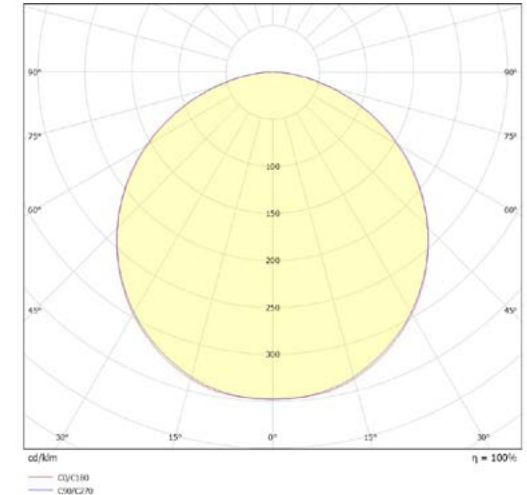

LIGHTING SPECIFICATIONS

- LED Globe Solo
- LED Spot Solo
- LED Globe Trio
- LED Spot Trio
- LED Globe Quintet
- LED Spot Quintet
- LED Line 85
- LED Line 125**
- LED Line 113
- LED Line 225
- LED Disk Ø 450
- LED Disk Ø 460
- LED Disk Ø 470
- LED Disk Ø 670

LED Line 125

Products

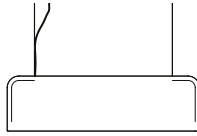

BuzziShield Light L

Description

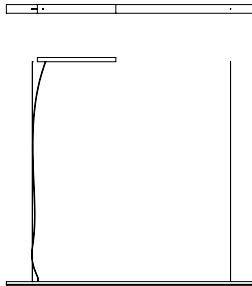

BuzziSpace LED Line 125 is a LED profile for continuous direct lighting. The unit consists of a powder-coated white profile finished with a polycarbonate diffuser. The light source is a LED strip made to perfectly fit the size of the LED Line 125.

Technical Characteristics

Certification	CE/CB	cULus
Input voltage	220 - 240V	110 - 120V / 277V
Lamp	1 x LED strip	1 x LED strip
Gear / Transfo	LEDGear incl	LED Gear incl
Gear settings	24V	24V
Luminaire power	17,5 W	21 W
Color temperature	3000K	3000K
IP	IP20	IP20
Source lifetime	50000hr	50000hr
CRI	90	90
Lumen output	1400 Lm	1400 Lm
Efficacy	80 Lm/w	67 Lm/w
Dimmability	0-10V or DALI	1-10V
UGR	22	22
MacAdam	5 SDCM	5 SDCM
Beam Angle	112,8°	112,8°

Photometric Data

Glare evaluation according to UGR											
μ Ceiling		70	70	50	50	30	70	70	50	50	30
μ Walls		50	30	50	30	30	50	30	50	30	30
μ Floor		20	20	20	20	20	20	20	20	20	20
Room size X Y		Viewing direction at right angles to lamp axis					Viewing direction parallel to lamp axis				
2H	2H	21.5	22.9	21.8	23.1	23.3	21.5	22.8	21.8	23.1	23.3
	3H	23.0	24.3	23.3	24.5	24.8	23.0	24.3	23.4	24.5	24.8
	4H	23.8	24.8	24.0	25.1	25.4	23.7	24.8	24.0	25.1	25.4
	6H	24.1	25.1	24.4	25.4	25.8	24.1	25.2	24.5	25.5	25.8
	8H	24.2	25.2	24.5	25.5	25.9	24.3	25.3	24.6	25.6	25.9
12H	24.2	25.3	24.6	25.6	25.9	24.3	25.4	24.7	25.7	26.0	
4H	2H	22.2	23.3	22.5	23.6	23.9	22.2	23.3	22.5	23.6	23.9
	3H	23.9	24.9	24.3	25.2	25.6	23.9	24.9	24.3	25.2	25.6
	4H	24.6	25.5	25.0	25.9	26.2	24.7	25.6	25.1	25.9	26.3
	6H	25.2	26.0	25.6	26.3	26.7	25.2	26.0	25.6	26.4	26.8
	8H	25.3	26.1	25.8	26.5	26.9	25.4	26.2	25.9	26.5	27.0
12H	25.4	26.1	25.9	26.5	27.0	25.5	26.2	26.0	26.6	27.1	
8H	4H	24.0	25.6	25.3	26.0	26.5	24.9	25.7	26.4	26.1	26.5
	6H	25.6	26.2	26.1	26.6	27.1	25.7	26.3	26.1	26.7	27.1
	8H	25.5	26.4	26.3	26.8	27.3	25.9	26.5	26.4	26.9	27.4
	12H	26.0	26.5	26.5	26.9	27.4	26.1	26.6	26.6	27.1	27.6
	4H	24.9	25.8	25.4	26.0	26.4	25.0	25.6	25.4	26.0	26.5
6H	25.7	26.2	26.1	26.6	27.1	25.7	26.2	26.2	26.7	27.2	
8H	25.9	26.4	26.4	26.9	27.4	26.0	26.5	26.5	26.9	27.4	
Variation of the observer position for the luminaire distances G											
S = 1.0H		+0.1 / -0.1					+0.1 / -0.1				
S = 1.5H		+0.2 / -0.4					+0.2 / -0.3				
S = 2.0H		+0.4 / -0.7					+0.4 / -0.6				
Standard table		BK06					BK06				
Correction Dimmnd		8.7					8.8				
Corrected glare indices referring to 1400lm Total luminous flux											

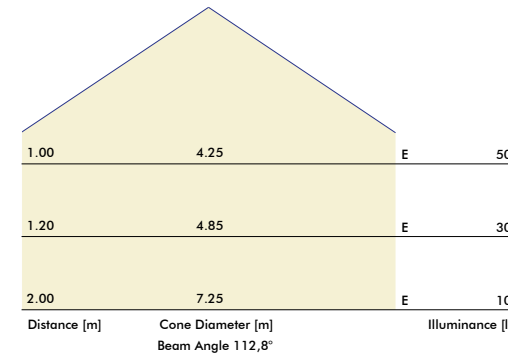
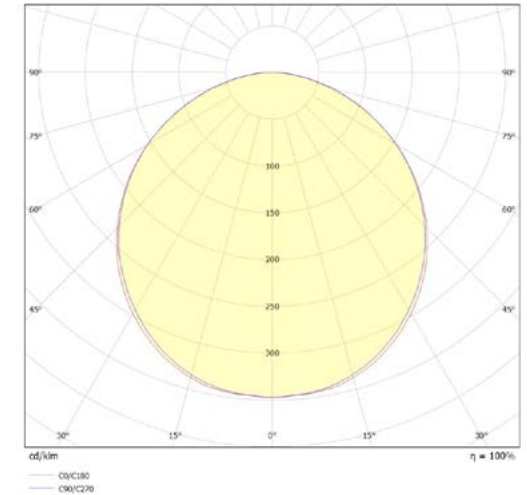

LIGHTING SPECIFICATIONS

- LED Globe Solo
- LED Spot Solo
- LED Globe Trio
- LED Spot Trio
- LED Globe Quintet
- LED Spot Quintet
- LED Line 85
- LED Line 125
- LED Line 113**
- LED Line 225
- LED Disk Ø 450
- LED Disk Ø 460
- LED Disk Ø 470
- LED Disk Ø 670

LED Line 113

Products

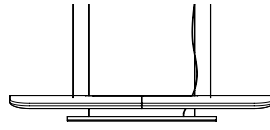

BuzziZepp Light S

Description

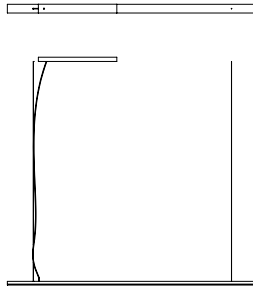

BuzziSpace LED Line 113 is a slim U-shaped LED profile for continuous direct lighting. The unit consists of a powder-coated black profile finished with a polycarbonate diffuser. The light source is a LED strip made to fit the size of the LED line 113.

Technical Characteristics

Certification	CE/CB	cULus
Input voltage	230V	120 - 277V
Lamp	1 x LED strip	1 x LED strip
Gear / Transfo	LED gear incl.	LED gear incl.
Gear settings	Set at 700mA	Set at 700mA
Luminaire power	33W	33W
Color temperature	3000K 2700K / 4000K (on request)	3000K
IP	IP20	IP20
Source lifetime	50000hrs L80 B10	50000hrs L80 B10
CRI	90	90
Lumen output	2300 Lm (Luminaire)	2300 Lm (Luminaire)
Efficacy	71 Lm/w	71 Lm/w
Dimmability	1 - 10V or Dali (on request)	1 - 10V
UGR	23	23
MacAdam	3 SDCM	3 SDCM
Beam angle	118.2°	118.2°

Photometric Data

Glare Evaluation According to UGR											
p Ceiling		70	70	50	50	30	70	70	50	50	30
p Walls		50	30	50	30	30	50	30	50	30	30
p Floor		20	20	20	20	20	20	20	20	20	20
Room size X	Y	Viewing direction at right angles to lamp axis					Viewing direction parallel to lamp axis				
2H	2H	19.1	20.4	19.4	20.7	20.9	19.2	20.5	19.5	20.8	21.0
	3H	20.6	21.9	21.0	22.1	22.4	20.8	22.0	21.1	22.3	22.6
	4H	21.2	22.4	21.6	22.7	23.0	21.5	22.6	21.8	22.9	23.2
	6H	21.6	22.7	22.0	23.0	23.4	22.0	23.0	22.3	23.4	23.7
	8H	21.7	22.8	22.1	23.1	23.4	22.2	23.2	22.5	23.5	23.9
4H	2H	19.8	20.9	20.2	21.2	21.6	19.9	21.0	20.2	21.3	21.6
	3H	21.5	22.5	21.9	22.9	23.2	21.7	22.7	22.1	23.0	23.4
	4H	22.2	23.1	22.7	23.5	23.9	22.5	23.3	22.9	23.7	24.1
	6H	22.8	23.5	23.2	23.9	24.3	23.1	23.9	23.5	24.3	24.7
	8H	22.9	23.6	23.4	24.0	24.5	23.3	24.1	23.6	24.5	24.9
8H	2H	23.0	23.6	23.5	24.1	24.5	23.5	24.2	24.0	24.6	25.1
	4H	22.6	23.3	23.0	23.7	24.1	22.8	23.5	23.2	23.9	24.3
	6H	23.2	23.8	23.7	24.2	24.7	23.5	24.1	24.0	24.6	25.0
	8H	23.4	23.9	23.9	24.4	24.9	23.9	24.4	24.4	24.8	25.3
	12H	23.6	24.0	24.1	24.5	25.0	24.2	24.6	24.7	25.1	25.6
12H	4H	22.6	23.2	23.0	23.7	24.1	22.8	23.4	23.2	23.8	24.3
	6H	23.3	23.8	23.8	24.3	24.8	23.6	24.1	24.1	24.6	25.1
	8H	23.6	24.0	24.1	24.5	25.0	24.0	24.4	24.5	24.9	25.4
	12H	23.6	24.0	24.1	24.5	25.0	24.0	24.4	24.5	24.9	25.4

Variation of the observerposition for the luminaire distance S

S = 1.5H	+0.1 / -0.1	+0.1 / -0.1
S = 1.5H	+0.2 / -0.3	+0.2 / -0.3
S = 2.0H	+0.4 / -0.7	+0.4 / -0.6

Standard table BK06 BK06
Correction summand 4.6 4.9
Corrected glare indices referring to 3544lm total luminous flux

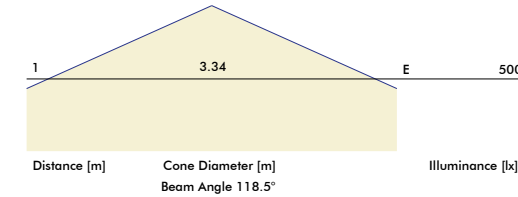
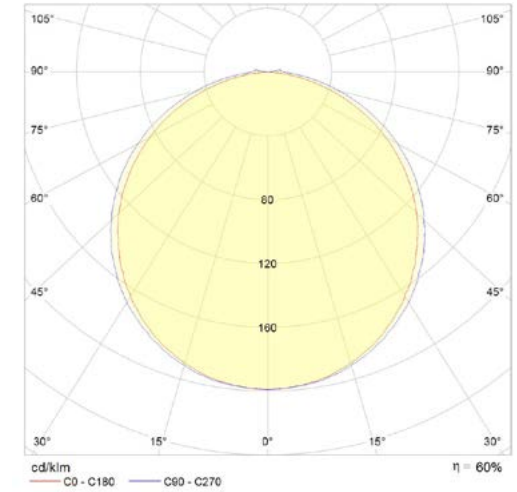

LIGHTING SPECIFICATIONS

- LED Globe Solo
- LED Spot Solo
- LED Globe Trio
- LED Spot Trio
- LED Globe Quintet
- LED Spot Quintet
- LED Line 85
- LED Line 125
- LED Line 113
- LED Line 225**
- LED Disk Ø 450
- LED Disk Ø 460
- LED Disk Ø 470
- LED Disk Ø 670

LED Line 225

Products

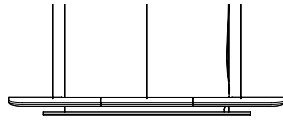

BuzziZepp Light M

Description

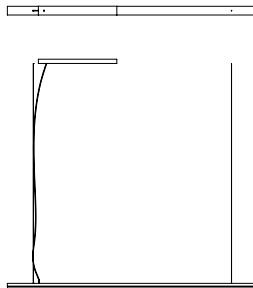

BuzziSpace LED Line 225 is a slim U-shaped LED profile for continuous direct lighting. The unit consists of a powder-coated black profile finished with a polycarbonate diffuser. The light source is a LED strip made to fit the size of the LED Line 225.

Technical Characteristics

Certification	CE/CB	cULus
Input voltage	230V	120 - 277V
Lamp	1 x LED strip	1 x LED strip
Gear / Transfo	LED gear incl.	LED gear incl.
Gear settings	Set at 700mA	Set at 700mA
Luminaire power	65W	65W
Color temperature	3000K 2700K / 4000K (on request)	3000K
IP	IP20	IP20
Source lifetime	50000hrs L80 B10	50000hrs L80 B10
CRI	90	90
Lumen output	4600 Lm	4600 Lm
Efficacy	71Lm/w	71Lm/w
Dimmability	1 - 10V or Dali (on request)	1 - 10V
UGR	23	23
MacAdam	3 SDCM	3 SDCM
Beam angle	118.2°	118.2°

Photometric Data

Glare Evaluation According to UGR											
Room size		Viewing direction at right angles to lamp axis					Viewing direction parallel to lamp axis				
X	Y										
2H	2H	19.2	20.5	19.6	20.8	21.0	19.1	20.6	19.4	20.7	21.0
3H	3H	20.8	22.0	21.1	22.3	22.6	20.7	21.9	21.0	22.2	22.5
4H	4H	21.6	22.6	21.8	22.9	23.2	21.3	22.4	21.6	22.7	23.0
6H	6H	22.0	23.0	22.4	23.4	23.7	21.7	22.7	22.0	23.0	23.4
8H	8H	22.2	23.2	22.5	23.5	23.9	21.8	22.8	22.2	23.1	23.5
12H	12H	22.3	23.3	22.7	23.6	24.0	21.8	22.8	22.2	23.2	23.5
4H	2H	19.9	21.0	20.2	21.3	21.6	19.8	21.0	20.2	21.3	21.6
3H	3H	21.7	22.7	22.1	23.0	23.4	21.5	22.5	21.9	22.9	23.2
4H	4H	22.5	23.3	22.9	23.7	24.1	22.3	23.1	22.7	23.5	23.9
6H	6H	23.1	23.9	23.5	24.3	24.7	22.8	23.5	23.2	23.9	24.4
8H	8H	23.4	24.1	23.8	24.5	24.9	22.9	23.6	23.4	24.1	24.5
12H	12H	23.5	24.2	24.0	24.6	25.1	23.0	23.7	23.5	24.1	24.6
8H	4H	22.8	23.5	23.2	23.9	24.3	22.6	23.3	23.0	23.7	24.1
6H	6H	23.5	24.1	24.0	24.6	25.1	23.2	23.8	23.7	24.3	24.7
8H	8H	23.9	24.4	24.4	24.9	25.4	23.5	24.0	24.0	24.4	24.9
12H	12H	24.2	24.6	24.7	25.1	25.6	23.6	24.1	24.1	24.5	25.1
12H	4H	22.8	23.4	23.2	23.9	24.3	22.6	23.3	23.1	23.7	24.1
6H	6H	23.6	24.1	24.1	24.6	25.1	23.3	23.8	23.8	24.3	24.8
8H	8H	24.0	24.4	24.5	24.9	25.4	23.6	24.0	24.1	24.5	25.0

Variation of the observer position for the luminaire distance S		
S = 1.0H	+0.1 / -0.1	+0.1 / -0.1
S = 1.5H	+0.2 / -0.3	+0.2 / -0.3
S = 2.0H	+0.4 / -0.6	+0.4 / -0.7

Standard table	BK06	BK06
Correction summand	+9	4.6

Corrected glare indices referring to 0.658lm total luminous flux

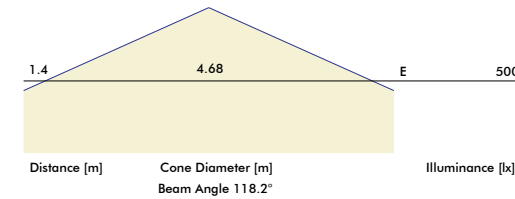
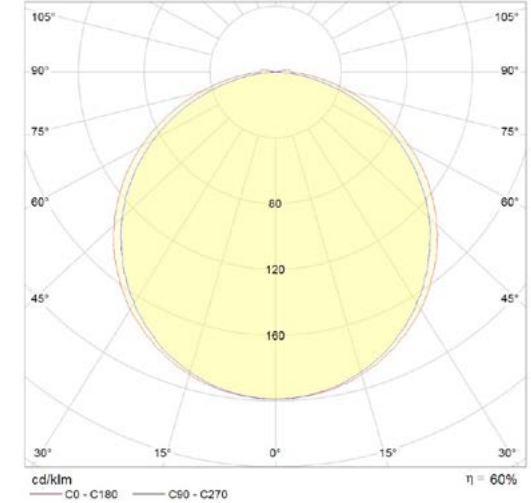

LIGHTING SPECIFICATIONS

- LED Globe Solo
- LED Spot Solo
- LED Globe Trio
- LED Spot Trio
- LED Globe Quintet
- LED Spot Quintet
- LED Line 85
- LED Line 125
- LED Line 113
- LED Line 225
- LED Disk Ø 450**
- LED Disk Ø 460
- LED Disk Ø 470
- LED Disk Ø 670

LED Disk Ø 450

Products

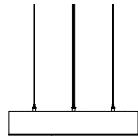

BuzziDisk

Description

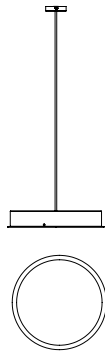

BuzziSpace LED Disk 450 is a downlight LED Module. It has an aluminum frame that is finished in fine-textured scratch-resistant powder coating. The front plate is a PMMA diffuser for optimum light spread and efficiency, which results in a very diffuse light surface and absolutely no dotfulness. The light source is a LED PCB, made to perfectly fit the size of the LED disk 450.

The LED disk 450 is not offered as a separate component but is always combined or integrated into a shade or acoustic body to make a complete luminaire.

Technical Characteristics

Certification	CE/CB	cULus
Input voltage	220 - 240V	120V
Lamp	1 x LED ARRAY	1 x LED ARRAY
Gear / Transfo	LEDGear incl	LED Gear incl
Gear settings	1200 mA	1200 mA
Luminaire power	35W	35W
Color temperature	3000K / 4000K	3000K / 4000K
IP	IP20	IP20
Source lifetime	50000hr	50000hr
CRI	90	90
Lumen output	3033 Lm	3033 Lm
Efficacy	86 Lm/W	86 Lm/W
Dimmability	1-10V or DALI	1-10V or DALI
UGR	19 or 22	19 or 22
MacAdam	5 SDCM	5 SDCM
Beam angle	105,65°	105,65°

Photometric Data

Test: 0:220.06V I:0.1716A P:34.221W PF:0.9063 Freq:50.01Hz Lamp Flux:3169.01x1 lm											
NAME:		TYPE:LED			WEIGHT:N/A						
SPEC.:N/A		DIM.:			SERIAL No.:N/A						
MFR.: solimeo		SUB.:			Shielding Angle:M/A						
ceiling/cavity	0.7	0.7	0.5	0.5	0.3	0.7	0.7	0.5	0.5	0.3	
walls	0.5	0.3	0.5	0.3	0.3	0.5	0.3	0.5	0.3	0.3	
working plane	0.2	0.2	0.2	0.2	0.2	0.2	0.2	0.2	0.2	0.2	
Room dimensions	Viewed crosswise					Viewed endwise					
x = 2H y = 2H	19.5	21.0	19.8	21.2	21.4	19.6	21.1	19.9	21.3	21.5	
3H	20.9	22.3	21.2	22.6	22.8	21.0	22.4	21.3	22.7	22.9	
4H	21.5	22.8	21.8	23.1	23.3	21.6	22.9	21.9	23.2	23.4	
6H	21.9	23.1	22.2	23.4	23.6	22.0	23.2	22.3	23.5	23.6	
8H	22.0	23.2	22.3	23.4	23.7	22.1	23.3	22.5	23.6	23.9	
12H	22.0	23.2	22.4	23.5	23.8	22.2	23.3	22.5	23.6	23.9	
4H	2H	20.1	21.4	20.4	21.7	22.0	20.2	21.5	20.5	21.7	22.0
3H	21.7	22.9	22.1	23.2	23.5	21.8	22.9	22.1	23.2	23.5	
4H	22.4	23.4	22.8	23.8	24.1	22.5	23.5	22.9	23.9	24.2	
6H	22.9	23.8	23.3	24.2	24.5	23.0	23.9	23.4	24.3	24.7	
8H	23.0	23.9	23.4	24.3	24.7	23.2	24.0	23.6	24.4	24.8	
12H	23.1	23.9	23.5	24.3	24.7	23.3	24.1	23.7	24.5	24.9	
6H	4H	22.6	23.5	23.0	23.9	24.3	22.7	23.6	23.1	24.0	24.3
8H	6H	23.3	24.0	23.7	24.4	24.8	23.4	24.1	23.8	24.5	24.9
12H	8H	23.5	24.1	24.0	24.6	25.0	23.6	24.3	24.1	24.7	25.1
12H	12H	23.7	24.2	24.1	24.7	25.1	23.8	24.3	24.3	24.9	25.3
12H	4H	22.6	23.4	23.1	23.8	24.2	22.7	23.5	23.2	23.9	24.3
6H	6H	23.3	24.0	23.8	24.4	24.8	23.4	24.1	23.9	24.5	24.9
8H	8H	23.6	24.1	24.1	24.6	25.1	23.7	24.3	24.2	24.7	25.2
Variations with the observer position at spacings:											
s = 1.0H	+ 0.2 / - 0.2					+ 0.2 / - 0.2					
1.5H	+ 0.2 / - 0.3					+ 0.2 / - 0.3					
2.0H	+ 0.2 / - 0.3					+ 0.2 / - 0.2					

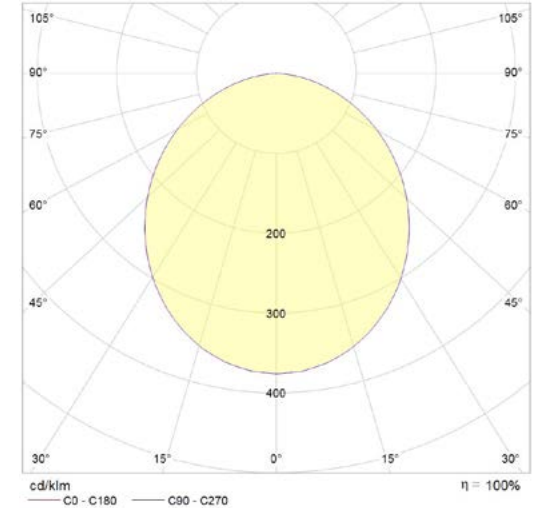
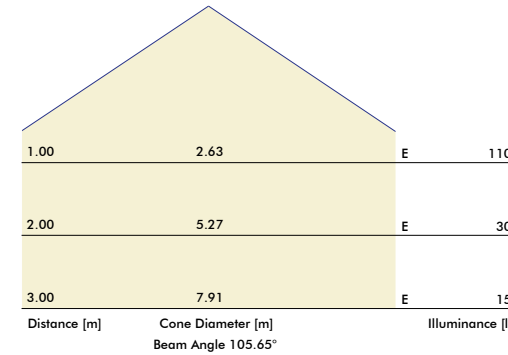

LIGHTING SPECIFICATIONS

- LED Globe Solo
- LED Spot Solo
- LED Globe Trio
- LED Spot Trio
- LED Globe Quintet
- LED Spot Quintet
- LED Line 85
- LED Line 125
- LED Line 113
- LED Line 225
- LED Disk Ø 450
- LED Disk Ø 460**
- LED Disk Ø 470
- LED Disk Ø 670

LED Disk Ø 460

Products

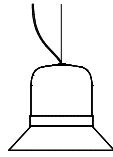

BuzziHat

Description

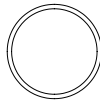

BuzziSpace LED Disk 460 is a downlight LED Module. It has an aluminum frame that is finished in fine-textured scratch-resistant white powder coating. The front plate is a PMMA diffuser for optimum light spread and efficiency, which results in a very diffuse light surface and absolutely no dottiness. The light source is a LED PCB, made to perfectly fit the size of the LED disk 460. The LED PCB contains 72 low-power LEDs.

The LED disk 460 is not offered as a separate component but is always combined or integrated into a shade or acoustic body to make a complete luminaire.

Technical Characteristics

Certification	CE/CB	cULus
Input voltage	230V	120 - 277V
Lamp	1 x LED Array	1 x LED Array
Gear / Transfo	LED gear incl.	LED gear incl.
Gear settings	Set at 700mA	Set at 700mA
Luminaire power	19 W	26 W
Color temperature	3000K	3000K
IP	IP20	IP20
Source lifetime	50000hrs L80 B20	50000hrs L80 B20
CRI	80	80
Lumen output	2009 Lm	2009 Lm
Efficacy	105 Lm/w	77 Lm/w
Dimmability	1 - 10V	1 - 10V
UGR	20 or 19	20
MacAdam	3 SDCM	3 SDCM
Beam angle	114.2°	114.2°

Photometric Data

Glare Evaluation According to UGR											
p. Ceiling		70	70	50	30	70	70	50	50	30	
p. Walls		50	30	50	30	50	30	50	30	30	
p. Floor		20	20	20	20	20	20	20	20	20	
Room size X	Y	Viewing direction at right angles to lamp axis					Viewing direction parallel to lamp axis				
2H	2H	16.6	17.9	16.9	18.2	18.4	16.6	18.0	16.9	18.2	18.4
	3H	18.2	19.4	18.6	19.6	19.9	18.2	19.4	18.6	19.6	19.9
	4H	18.7	19.8	19.0	20.1	20.4	18.7	19.8	19.1	20.1	20.4
	6H	19.0	20.0	19.3	20.3	20.6	19.0	20.0	19.4	20.3	20.7
	8H	19.0	20.0	19.4	20.3	20.7	19.0	20.0	19.4	20.3	20.7
4H	12H	19.0	19.9	19.4	20.3	20.6	19.0	20.0	19.4	20.3	20.6
	2H	17.3	18.4	17.7	18.7	19.0	17.3	18.6	17.7	18.7	19.0
	3H	19.0	20.0	19.4	20.3	20.6	19.0	20.0	19.4	20.3	20.7
	4H	19.7	20.6	20.1	20.9	21.2	19.7	20.6	20.1	20.9	21.2
	6H	20.0	20.8	20.6	21.2	21.6	20.1	20.8	20.5	21.2	21.6
8H	8H	20.1	20.8	20.6	21.2	21.6	20.1	20.8	20.6	21.2	21.6
	12H	20.1	20.7	20.6	21.1	21.5	20.1	20.7	20.6	21.1	21.5
	4H	19.9	20.6	20.4	21.0	21.4	19.9	20.6	20.4	21.0	21.4
	6H	20.4	20.9	20.8	21.3	21.8	20.4	20.9	20.8	21.4	21.8
	8H	20.4	20.9	20.9	21.4	21.8	20.5	20.9	20.9	21.4	21.9
12H	12H	20.4	20.9	20.9	21.3	21.8	20.4	20.9	20.9	21.3	21.8
	4H	19.9	20.5	20.4	20.9	21.4	19.9	20.5	20.4	20.9	21.4
	6H	20.4	20.9	20.9	21.3	21.8	20.4	20.9	20.9	21.3	21.8
8H	20.5	20.9	21.0	21.5	21.9	20.5	20.9	21.0	21.3	21.8	

Variation of the observerposition for the luminaire distance S		
S = 1.0H	+0.1 / -0.1	+0.1 / -0.1
S = 1.5H	+0.3 / -0.4	+0.3 / -0.4
S = 2.0H	+0.5 / -0.7	+0.5 / -0.8
Standard table	BK05	BK05
Correction summand	3.1	3.1

Corrected glare indices referring to 2000lm total luminous flux.

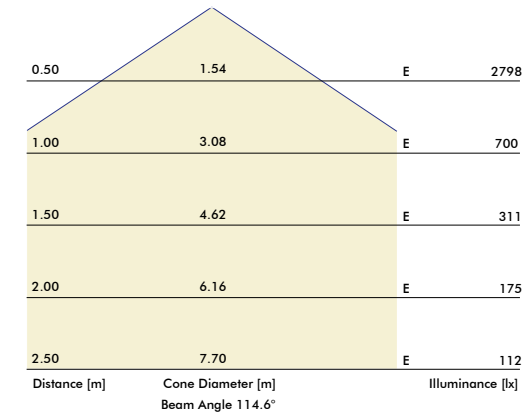
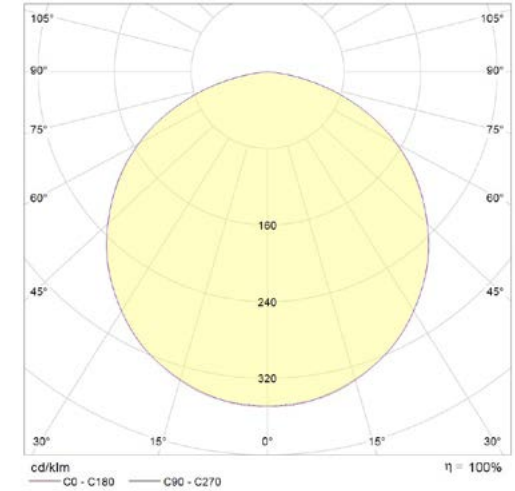

LIGHTING SPECIFICATIONS

- LED Globe Solo
- LED Spot Solo
- LED Globe Trio
- LED Spot Trio
- LED Globe Quintet
- LED Spot Quintet
- LED Line 85
- LED Line 125
- LED Line 113
- LED Line 225
- LED Disk Ø 450
- LED Disk Ø 460
- LED Disk Ø 470**
- LED Disk Ø 670

LED Disk Ø 470

Products

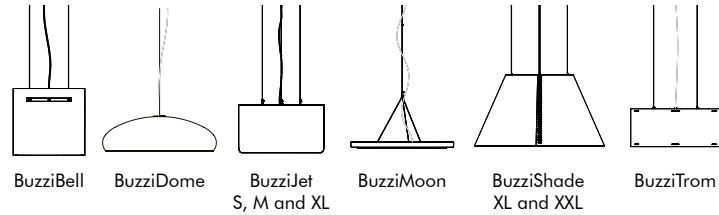

Description

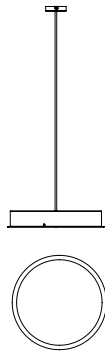

BuzziSpace LED Disk 470 is a downlight LED light source for recessed use in an upholstered panel/body or mounted on a shade. It has an aluminum frame that is finished in fine-textured scratch-resistant white powder coating. The front plate is a PMMA diffuser for optimum light spread and efficiency, which results in a very diffuse light surface and absolutely no dottiness. The light source is a LED PCB, made to perfectly fit the size of the LED disk 470. The LED PCB contains 104 medium power LEDs with very high CRI and CCT.

The LED disk 470 is not offered as a separate component but is always combined or integrated into a shade or acoustic body to make a complete luminaire.

Technical Characteristics

Certification	CE/CB	cULus
Input voltage	230V	120 - 277V
Lamp	1x med-power LED 25.9W	1x med-power LED 25.9W
Gear / Transfo	LED gear incl.	LED gear incl.
Gear settings	Set at 700mA	Set at 700mA
Luminaire power	29,4W	29,4W
Color temperature	3000K or 4000K	3000K
IP	IP20	IP20
Source lifetime	50000hrs L80 B20	50000hrs L80 B20
CRI	90	90
Lumen output	2545 Lm	2545 Lm
Efficacy	87 Lm/w	87 Lm/w
Dimmability	1 - 10V or Dali	1 - 10V
UGR	22 or 19	22
MacAdam	3 SDCM	3 SDCM
Beam angle	112.4°	112.4°

Photometric Data

Glare Evaluation According to UGR												
Room size		Viewing direction at right angles to lamp axis					Viewing direction parallel to lamp axis					
X	Y	2H	3H	4H	6H	8H	12H	2H	3H	4H	6H	8H
0 Ceiling	70	70	50	50	30	70	70	50	50	30	70	70
0 Walls	50	30	50	30	30	50	30	50	30	30	50	30
0 Floor	20	20	20	20	20	20	20	20	20	20	20	20
2H	2H	18.6	19.9	18.9	20.2	20.4	18.6	19.9	18.9	20.2	20.4	20.4
3H	3H	20.3	21.5	20.6	21.8	22.0	20.3	21.5	20.6	21.8	22.0	22.0
4H	4H	21.0	22.1	21.3	22.4	22.7	21.0	22.1	21.3	22.4	22.7	22.7
6H	6H	21.8	22.6	21.9	22.9	23.2	21.8	22.6	21.9	22.9	23.2	23.3
8H	8H	21.8	22.8	22.1	23.1	23.4	21.8	22.8	22.1	23.1	23.4	23.4
12H	12H	21.9	22.9	22.3	23.2	23.6	21.9	22.9	22.3	23.2	23.6	23.6
4H	2H	19.3	20.5	19.7	20.8	21.0	19.3	20.5	19.7	20.8	21.0	21.0
3H	3H	21.2	22.2	21.6	22.5	22.8	21.2	22.2	21.6	22.5	22.8	22.8
4H	4H	22.0	22.9	22.4	23.3	23.6	22.0	22.9	22.4	23.3	23.6	23.6
6H	6H	22.8	23.5	23.2	23.9	24.3	22.8	23.5	23.2	23.9	24.3	24.3
8H	8H	23.0	23.7	23.5	24.1	24.5	23.0	23.7	23.5	24.1	24.5	24.5
12H	12H	23.2	23.9	23.7	24.3	24.7	23.2	23.9	23.7	24.3	24.7	24.7
8H	4H	22.4	23.1	22.8	23.5	23.9	22.4	23.1	22.8	23.5	23.9	23.9
6H	6H	23.3	23.8	23.7	24.3	24.7	23.3	23.9	23.7	24.3	24.7	24.7
8H	8H	23.8	24.1	24.1	24.6	25.1	23.8	24.1	24.1	24.6	25.1	25.1
12H	12H	23.9	24.4	24.4	24.8	25.3	23.9	24.4	24.4	24.8	25.3	25.3
4H	4H	22.4	23.1	22.9	23.6	23.9	22.4	23.1	22.9	23.6	23.9	23.9
6H	6H	23.4	23.9	23.8	24.3	24.8	23.4	23.9	23.8	24.3	24.8	24.8
8H	8H	23.8	24.2	24.3	24.7	25.2	23.8	24.2	24.3	24.7	25.2	25.2

Variation of the observer position for the luminaires distance S

S	+0.1 / -0.1	+0.1 / -0.1
S = 1.0H	+0.1 / -0.1	+0.1 / -0.1
S = 1.5H	+0.2 / -0.3	+0.2 / -0.3
S = 2.0H	+0.3 / -0.6	+0.3 / -0.6

Standard table BK07 BK07

Correction summand 5.9 5.9

Corrected glare indices referring to 322 lm total luminous flux

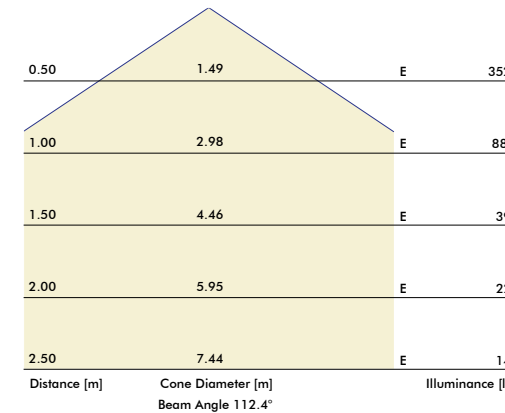
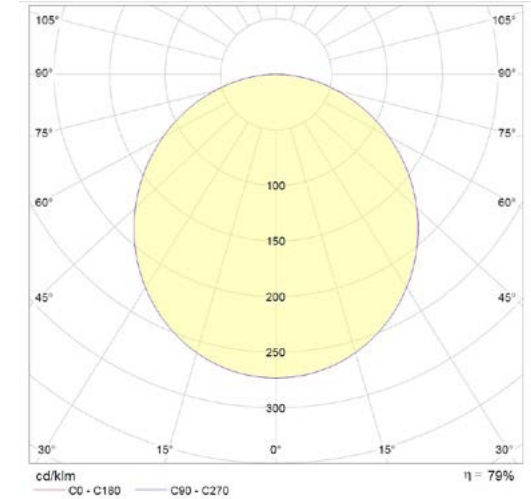

LIGHTING SPECIFICATIONS

- LED Globe Solo
- LED Spot Solo
- LED Globe Trio
- LED Spot Trio
- LED Globe Quintet
- LED Spot Quintet
- LED Line 85
- LED Line 125
- LED Line 113
- LED Line 225
- LED Disk Ø 450
- LED Disk Ø 460
- LED Disk Ø 470
- LED Disk Ø 670**

LED Disk Ø 670

Products

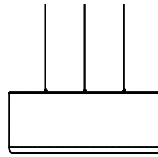

BuzziJet XXL

Description

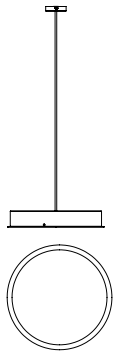

BuzziSpace LED Disk 670 is a downlight LED light source for recessed use in an upholstered panel/body or mounted on a shade. It has an aluminum frame that is finished in fine-textured scratch-resistant white powder coating. The front plate is a PMMA diffuser for optimum light spread and efficiency, which results in a very diffuse light surface and absolutely no dottness. The light source is a LED PCB, made to perfectly fit the size of the LED disk 670. The LED PCB contains 248 medium power LEDs with very high CRI and CCT.

The LED disk 670 is not offered as a separate component but is always combined or integrated into a shade or acoustic body to make a complete luminaire.

Technical Characteristics

Certification	CE/CB	cULus
Input voltage	230V	120V
Lamp	1x med-power LED 62W	1x med-power LED 62W
Gear / Transfo	LED gear incl.	LED gear incl.
Gear settings	Set at 700mA	Set at 700mA
Luminaire power	70W	70W
Color temperature	3000K	3000K
IP	IP20	IP20
Source lifetime	50000hrs L80 B20	50000hrs L80 B20
CRI	90	90
Lumen output	6232 Lm	6232 Lm
Efficacy	89 Lm/w	89 Lm/w 89 Lm/w
Dimmability	1 - 10V	1 - 10V
UGR	23	23
MacAdam	3 SDCM	3 SDCM
Beam angle	109.2°	109.2°

Photometric Data

Glare evaluation according to UGR													
Room size		Viewing direction at right angles to lamp axis					Viewing direction parallel to lamp axis						
X	Y	2H	3H	4H	6H	8H	12H	2H	3H	4H	6H	8H	12H
⊥ Ceiling		70	70	50	50	30	70	70	50	50	30	70	70
⊥ Walls		50	30	50	30	30	50	30	50	30	30	50	30
⊥ Floor		20	20	20	20	20	20	20	20	20	20	20	20
2H	2H	19.0	20.4	19.3	20.6	20.8	19.0	20.3	19.3	20.6	20.8	19.0	20.3
3H	3H	20.6	21.9	20.9	22.1	22.4	20.6	21.9	20.9	22.1	22.4	20.6	21.9
4H	4H	21.3	22.5	21.7	22.8	23.1	21.3	22.5	21.6	22.8	23.1	21.3	22.5
6H	6H	21.9	23.0	22.2	23.3	23.6	21.9	23.0	22.2	23.3	23.6	21.9	23.0
8H	8H	22.0	23.1	22.4	23.4	23.7	22.0	23.1	22.4	23.4	23.7	22.0	23.1
12H	12H	22.2	23.2	22.5	23.5	23.9	22.2	23.2	22.5	23.5	23.9	22.2	23.2
4H	2H	19.7	20.9	20.0	21.1	21.4	19.7	20.9	20.0	21.1	21.4	19.7	20.9
3H	3H	21.5	22.5	21.9	22.6	23.2	21.5	22.5	21.9	22.6	23.2	21.5	22.5
4H	4H	22.3	23.3	22.8	23.6	24.0	22.3	23.3	22.7	23.6	24.0	22.3	23.3
6H	6H	23.0	23.8	23.6	24.2	24.6	23.0	23.8	23.6	24.2	24.6	23.0	23.8
8H	8H	23.3	24.0	23.7	24.4	24.8	23.3	24.0	23.7	24.4	24.8	23.3	24.0
12H	12H	23.5	24.1	23.9	24.6	25.0	23.5	24.1	23.9	24.6	25.0	23.5	24.1
8H	4H	22.7	23.4	23.1	23.8	24.2	22.7	23.4	23.1	23.8	24.2	22.7	23.4
6H	6H	23.5	24.1	24.0	24.6	25.0	23.5	24.1	24.0	24.6	25.0	23.5	24.1
8H	8H	23.9	24.4	24.4	24.9	25.3	23.9	24.4	24.4	24.9	25.3	23.9	24.4
12H	12H	24.1	24.6	24.6	25.1	25.6	24.1	24.6	24.6	25.1	25.6	24.1	24.6
12H	4H	22.7	23.4	23.2	23.6	24.2	22.7	23.4	23.2	23.6	24.2	22.7	23.4
6H	6H	23.6	24.2	24.1	24.6	25.1	23.6	24.2	24.1	24.6	25.1	23.6	24.2
8H	8H	24.0	24.5	24.5	24.9	25.4	24.0	24.5	24.5	24.9	25.4	24.0	24.5

Variation of the observer position for the luminaire distances 5		
S = 1.0H	+0.1 / -0.1	+0.1 / -0.1
S = 1.5H	+0.2 / -0.3	+0.2 / -0.3
S = 2.0H	+0.3 / -0.5	+0.3 / -0.5
Standard table	BK06	BK06
Correction Summand	5.8	5.8

Corrected glare indices referring to 7775lm Total luminous flux

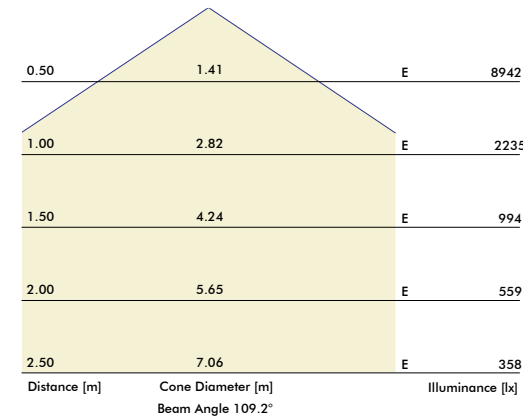
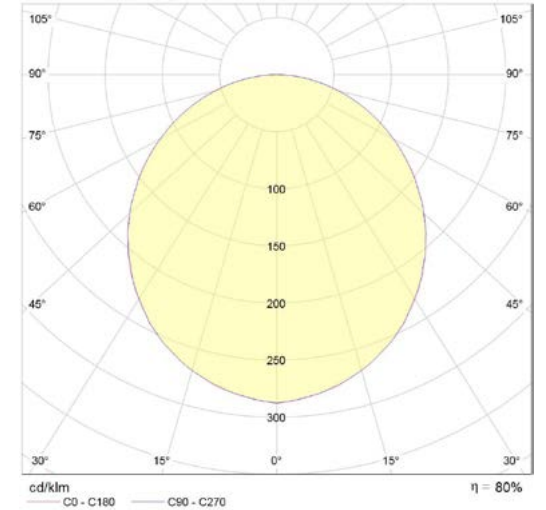



Acoustic Expertise

132. How It Works

134. Inspirational Settings

134. Meeting Rooms

135. Open Spaces

136. Lobbies

137. Coffee Corners / Cafeterias

Acoustic Lighting

How It Works

With plenty of designs and materials to choose from, the question remains: “how do these two elements impact acoustic performance?” Let’s take a closer look so you can make an informed decision on choosing the best acoustic lighting solution for your space.

Choosing an acoustic lighting solution should not be done at random. It’s important to note that various acoustic issues and challenges require different solutions. Three main features that typically define the performance of acoustic lighting are density, size, and shape.

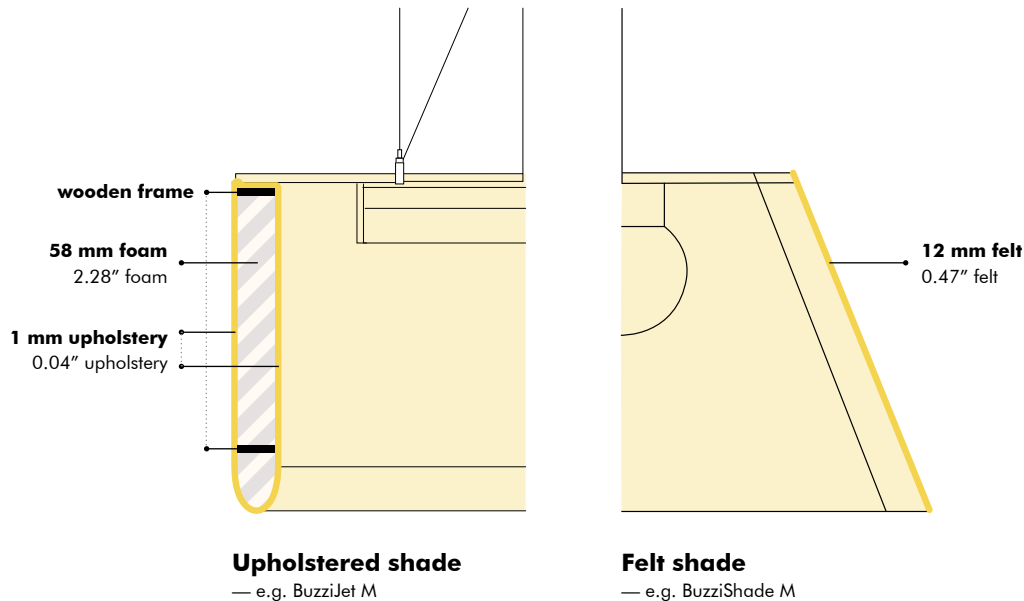

Density

Density refers to both the mass and volume of acoustic materials. To absorb low tones, density is critical. Choose foam-upholstered products, such as BuzziHat and BuzziDome.

To reduce high-frequency noises, less material is needed. Pendant lights made of felt are best for these scenarios, for instance, BuzziShade and BuzziTrom.

Rule of thumb: low tones require more acoustic material to be absorbed than high tones.



Size

The size of your space will naturally delimit the dimensions of your light sources. Acoustically, size is also critical, especially in terms of the air gaps or cavities as these have an impact on the ability to trap sound waves.

BuzziJet and BuzziProp trap sound waves within the radius of their circular body. Because BuzziProp is narrower and smaller than BuzziJet, the cavity is more concentrated and will better soak up sound waves before they escape the cylinder.

Rule of thumb: Length, width, and diameter determine how well the acoustic lighting picks up sound.



Shape

Just like size affects acoustic performance, so does shape. The conic shape of BuzziShade and BuzziCone is excellent for capturing sound waves within the core, while its round shape helps to diffuse sound energy better.

However, not all acoustic lighting solutions are designed with a circular body. BuzziZepp Light is an exception with its panel-shaped silhouette. The soft edges diffuse sounds too, but BuzziZepp Light is especially a powerhouse for immediate absorption.



Meeting Rooms

The meeting room is a typical example where the correct lighting and acoustics are necessary to make conversations between participants clear and pleasant. Presentations also require specific indirect lighting for maximum visibility of the screen.



Open Spaces

The popular open-office model connects workers, but, at the same time, privacy and silence are necessary. We call this working apart together.

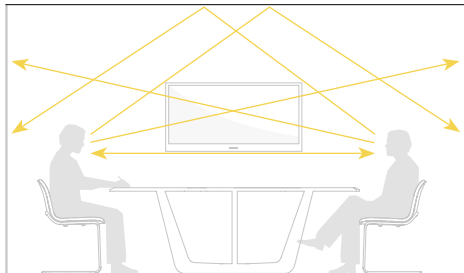

Challenges

- Speech clarity.
- Concentration time.
- Adequate lighting for different functionalities.

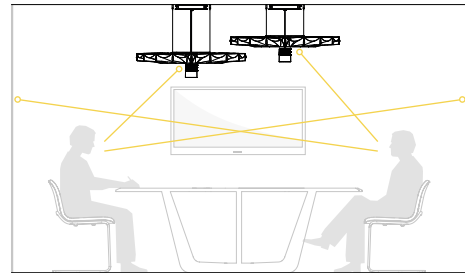

Solutions

- BuzziPleat Light traps mid and low tones within its folds while delivering the necessary light output above the table.
- Add acoustic wall treatments like BuzziSkin or BuzziTile to reduce mid and high tones emitting from speech and typing sounds.

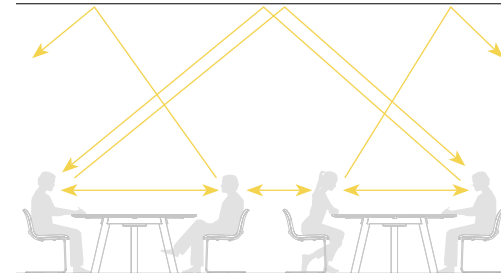

Challenges

- Reduce and manage noise from conversations, phone calls, informal talks, etc.
- Create privacy.
- Functional task light.

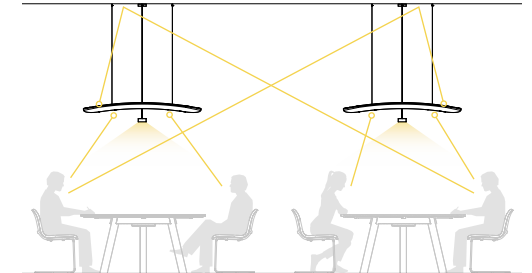

Solutions

- BuzziZepp Light offers the necessary light output on the workstation and prevents sound from traveling to other areas while absorbing low, mid, and high tones.



Lobbies

The hotel or office lobby is the spot where people gather. To ensure privacy at the welcome desk and in the waiting area, these very noisy and multifunctional spaces require specific acoustic care and adequate lighting.

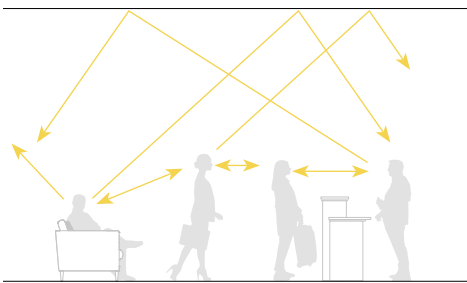

Challenges

- Create privacy.
- Manage sound transfers from groups.
- Avoid overhearing phone calls.
- Adequate lighting for different settings.

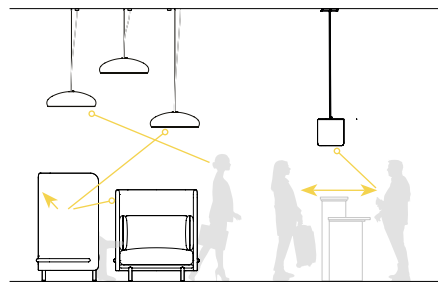

Solutions

- BuzziSpark minimizes sound transfers with its shields and limits external background noise to a minimum. Combining different sizes ensures cozy nooks for phone calls or meeting informally.
- Recharge in a quiet oasis under a sea of BuzziDome acoustic pendant lights. When clustered, they create a warm and comfortable sphere that soaks up undesired noise inside their dome-shaped body.
- BuzziProp captures sound waves within its cylindrical design.



Coffee Corners / Cafeterias

Disconnect for 10 minutes, take a lunch break, or get together for an informal chat at the coffee machine. To create happy and healthy settings, along with cozy corners, acoustics and lighting are crucial. This not only applies to offices, but just as well to residential environments including open space kitchens and living rooms.

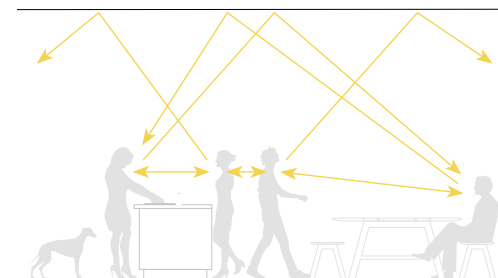

Challenges

- Manage high-pitched sounds.
- Create cozy corners in open spaces.
- Establish different settings in one room.

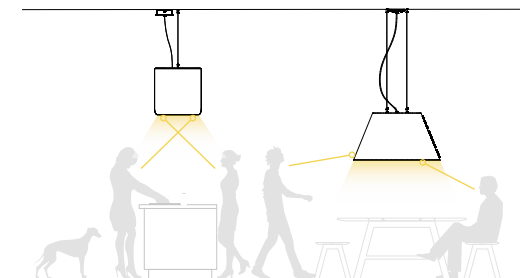

Solutions

- BuzziShade creates separated settings with ambient light and can control sound transfers.
- BuzziProp regulates noise and creates a warm setting.
- Cluster several BuzziShade pendants to create additional air cavities and maximize absorption.

Materials

FELTS & FABRICS

- 140. Application Overview**
- 142. Specifications Overview**
- 144. Felt**
 - 144. BuzziFelt
- 146. Category A**
 - 146. Fabric
 - 147. Revive 1
 - 148. Trevira CS / Trevira CS+
- 150. Category B**
 - 150. Clara 2
 - 152. Remix 3
 - 154. Velvet

156. Category C

- 156. Hero

157. Category D

- 157. Tonus 4

158. Category E

- 158. Memory 2

SOLID MATERIALS

160. Application Overview

162. Metal

- 162. Powder-Coated Metal
- 162. Uncoated Aluminum



APPLICATION OVERVIEW

Felts & Fabrics

- Not possible
- Possible

Product	Felt	CAT A				CAT B			CAT C	CAT D	CAT E
		Fabric	Revive 1	Trevira CS	Trevira CS+	Clara 2	Remix 3	Velvet	Hero	Tonus 4	Memory 2
	100% Recycl. P.E.T. Felt	75% Recycled Wool 25% Recycled Polyacryl	100% Recycl. polyester FR	100% Trevira	100% Trevira	92% New Wool worsted 8% Nylon	90% New Wool worsted 10% Nylon	100% polyester	96% New Wool 4% Nylon	90% New Wool 10% Helanca	100% Trevira CS
BuzziBell	<input checked="" type="radio"/>	<input type="radio"/>	<input type="radio"/>	<input type="radio"/>	<input type="radio"/>	<input type="radio"/>	<input type="radio"/>	<input type="radio"/>	<input type="radio"/>	<input type="radio"/>	<input type="radio"/>
BuzziChandelier	<input checked="" type="radio"/>	<input type="radio"/>	<input type="radio"/>	<input type="radio"/>	<input type="radio"/>	<input type="radio"/>	<input type="radio"/>	<input type="radio"/>	<input type="radio"/>	<input type="radio"/>	<input type="radio"/>
BuzziChip	<input type="radio"/>	<input checked="" type="radio"/>	<input checked="" type="radio"/>	<input checked="" type="radio"/>	<input checked="" type="radio"/>	<input checked="" type="radio"/>	<input checked="" type="radio"/>	<input checked="" type="radio"/>	<input checked="" type="radio"/>	<input checked="" type="radio"/>	<input checked="" type="radio"/>
BuzziCone	<input checked="" type="radio"/>	<input checked="" type="radio"/>	<input type="radio"/>	<input type="radio"/>	<input type="radio"/>	<input type="radio"/>	<input type="radio"/>	<input type="radio"/>	<input checked="" type="radio"/>	<input type="radio"/>	<input type="radio"/>
BuzziDisk	<input checked="" type="radio"/>	<input checked="" type="radio"/>	<input type="radio"/>	<input type="radio"/>	<input type="radio"/>	<input type="radio"/>	<input type="radio"/>	<input type="radio"/>	<input type="radio"/>	<input type="radio"/>	<input type="radio"/>
BuzziDome	<input type="radio"/>	<input checked="" type="radio"/>	<input type="radio"/>	<input checked="" type="radio"/>	<input checked="" type="radio"/>	<input checked="" type="radio"/>	<input checked="" type="radio"/>	<input type="radio"/>	<input checked="" type="radio"/>	<input checked="" type="radio"/>	<input checked="" type="radio"/>
BuzziFez	<input checked="" type="radio"/>	<input type="radio"/>	<input type="radio"/>	<input type="radio"/>	<input type="radio"/>	<input type="radio"/>	<input type="radio"/>	<input type="radio"/>	<input type="radio"/>	<input type="radio"/>	<input type="radio"/>
BuzziHat	<input type="radio"/>	<input checked="" type="radio"/>	<input checked="" type="radio"/>	<input checked="" type="radio"/>	<input checked="" type="radio"/>	<input checked="" type="radio"/>	<input checked="" type="radio"/>	<input checked="" type="radio"/>	<input checked="" type="radio"/>	<input checked="" type="radio"/>	<input checked="" type="radio"/>
BuzziJet	<input type="radio"/>	<input checked="" type="radio"/>	<input checked="" type="radio"/>	<input checked="" type="radio"/>	<input checked="" type="radio"/>	<input checked="" type="radio"/>	<input checked="" type="radio"/>	<input type="radio"/>	<input checked="" type="radio"/>	<input checked="" type="radio"/>	<input checked="" type="radio"/>
BuzziJet Standing	<input type="radio"/>	<input checked="" type="radio"/>	<input checked="" type="radio"/>	<input checked="" type="radio"/>	<input checked="" type="radio"/>	<input checked="" type="radio"/>	<input checked="" type="radio"/>	<input type="radio"/>	<input checked="" type="radio"/>	<input checked="" type="radio"/>	<input checked="" type="radio"/>
BuzziLight Mono	<input checked="" type="radio"/>	<input type="radio"/>	<input type="radio"/>	<input type="radio"/>	<input type="radio"/>	<input type="radio"/>	<input type="radio"/>	<input type="radio"/>	<input type="radio"/>	<input type="radio"/>	<input type="radio"/>
BuzziMoon	<input type="radio"/>	<input checked="" type="radio"/>	<input checked="" type="radio"/>	<input checked="" type="radio"/>	<input checked="" type="radio"/>	<input checked="" type="radio"/>	<input checked="" type="radio"/>	<input type="radio"/>	<input checked="" type="radio"/>	<input checked="" type="radio"/>	<input checked="" type="radio"/>
BuzziPleat Light	<input checked="" type="radio"/>	<input type="radio"/>	<input type="radio"/>	<input type="radio"/>	<input type="radio"/>	<input type="radio"/>	<input type="radio"/>	<input type="radio"/>	<input type="radio"/>	<input type="radio"/>	<input type="radio"/>
BuzziProp	<input type="radio"/>	<input checked="" type="radio"/>	<input checked="" type="radio"/>	<input checked="" type="radio"/>	<input checked="" type="radio"/>	<input checked="" type="radio"/>	<input checked="" type="radio"/>	<input type="radio"/>	<input checked="" type="radio"/>	<input checked="" type="radio"/>	<input checked="" type="radio"/>
BuzziShade	<input checked="" type="radio"/>	<input checked="" type="radio"/>	<input type="radio"/>	<input type="radio"/>	<input type="radio"/>	<input type="radio"/>	<input type="radio"/>	<input type="radio"/>	<input checked="" type="radio"/>	<input type="radio"/>	<input type="radio"/>
BuzziShade Standing	<input checked="" type="radio"/>	<input type="radio"/>	<input type="radio"/>	<input type="radio"/>	<input type="radio"/>	<input type="radio"/>	<input type="radio"/>	<input type="radio"/>	<input type="radio"/>	<input type="radio"/>	<input type="radio"/>
BuzziShade Square	<input checked="" type="radio"/>	<input type="radio"/>	<input type="radio"/>	<input type="radio"/>	<input type="radio"/>	<input type="radio"/>	<input type="radio"/>	<input type="radio"/>	<input type="radio"/>	<input type="radio"/>	<input type="radio"/>
BuzziShield Light	<input type="radio"/>	<input checked="" type="radio"/>	<input checked="" type="radio"/>	<input checked="" type="radio"/>	<input checked="" type="radio"/>	<input checked="" type="radio"/>	<input checked="" type="radio"/>	<input checked="" type="radio"/>	<input checked="" type="radio"/>	<input checked="" type="radio"/>	<input checked="" type="radio"/>
BuzziTrom	<input checked="" type="radio"/>	<input type="radio"/>	<input type="radio"/>	<input type="radio"/>	<input type="radio"/>	<input type="radio"/>	<input type="radio"/>	<input type="radio"/>	<input type="radio"/>	<input type="radio"/>	<input type="radio"/>
BuzziZepp Light	<input type="radio"/>	<input checked="" type="radio"/>	<input checked="" type="radio"/>	<input checked="" type="radio"/>	<input checked="" type="radio"/>	<input checked="" type="radio"/>	<input checked="" type="radio"/>	<input checked="" type="radio"/>	<input checked="" type="radio"/>	<input checked="" type="radio"/>	<input checked="" type="radio"/>

Find the latest update of the application overview on our website: www.buzzi.space

FELT — BuzziFelt

Composition 100% Recycled PE.T. Felt, latex backing
Weight 1.000 g/m² | 29.49 oz/yd²
Width 170 cm | 66.93"
Thickness 6 mm | 0.236"
Abrasion resistance >7.000 Martindale
Flammability EU: EN 13501.1 + A1/2009 Class B-s1,d0
 USA: ASTM E84 Class A certified
Fastness to light EU: 6-7 | USA: 5
Maintenance Vacuum clean regularly. Don't wash. Don't remove the BuzziFelt from the product. Treat spillages immediately. Professional dry clean or wipe clean with a pH neutral soap and a damp cloth.



CAT A — Revive 1 kvadrat

Composition 100% recycled polyester FR
Weight 420 g/lin.m
Width 140 cm | 55.11"
Abrasion resistance 60.000 Martindale rubs, EN ISO 12947
Flammability EN 1021-1/2 | DIN 4102 B1 | Önorm B1/Q1
 UNI 9175 11M | US Cal. Tech. Bull. 117
 IMO A.652 (16)
Fastness to light Note 5-7, ISO 105-B02
Fastness to rubbing (ISO) dry 5, wet 4-5
Pilling Note 4-5, EN ISO 12945
Maintenance Vacuuming and dry cleaning.
 Washable at max. 60°C. Drip drying.



CAT B — CLARA 2 kvadrat

Composition 92% new wool, 8% nylon
Weight 400 g/lin.m
Width 138 cm | 54.33"
Abrasion resistance 80.000 Martindale rubs, EN ISO 12947
Flammability EN 1021-1/2 | BS 5852, ignition source 2-3 | DIN 4102 B2
 NF D 60 013 | UNI 9175 11M | US Cal. Tech. Bull. 117,
 Sec. E
 NFPA 260 | IMO A.652(16)
Fastness to light Note 5-7, ISO 105-B02
Fastness to rubbing (ISO) dry 4-5, wet 4
Pilling Note 4, EN ISO 12945
Maintenance Vacuuming and dry cleaning



CAT A — Fabric

Composition 75% Recycled Wool, 25% Recycled Polyacryl,
Weight 405 g/m² | 11.94 oz/yd²
Width 148 cm | 58.27"
Thickness 0,8 mm | 0.031 inch
Abrasion resistance 40.000 Martindale, 50.000 Wyzenbeek
Flammability EU: EN 1021.1/2006 | BS EN 1021.1/2006 (cigarette)
 EN 1021.2/2006 | BS EN 1021.2/2006 (match)
 USA: CAL TB 117 | ASTM E84 CLASS A
Fastness to light EU: 4 | USA: 4
Fastness to rubbing EU: Wet 3-4 | Dry 4-5
Fastness to crocking USA: Wet 5 | Dry 5
Maintenance Vacuum clean regularly. Don't wash. Don't remove the Fabric from the product. Treat spillages immediately. Professional dry clean or wipe clean with a pH neutral soap and a damp cloth.



CAT A — Trevira CS / Trevira CS+

Composition 100% Polyester, Trevira CS
Weight 420 g/m² | 12.39 oz/yd²
Width Trevira CS+ 150 cm | 59.06" / Trevira CS 140 cm | 55.12"
Abrasion resistance 100.000 Martindale, 90.000 Wyzenbeek
Flammability EU: BS 5852 part II: CRIB 5 | BS 7176 Medium Hazard
 M1 | B1 | C1 | EN 1021/1-2 | IMO Res. A652 (16)
 USA: CAL TB 117
Fastness to light EU: 6 | USA: 5
Fastness to rubbing EU: Wet 4-5 | Dry 4-5
Fastness to crocking USA: Wet 5 | Dry 5
Match Weight ±5% | Width ±2%
Maintenance Vacuum clean regularly. Don't remove the Trevira CS+ from the product. Treat spillages immediately. Professional dry clean or wipe clean with a pH neutral soap and a damp cloth.



CAT B — REMIX 3 kvadrat

Composition 90% new wool, 10% nylon
Weight 415 g/lin.m
Width 138 cm | 54.33"
Abrasion resistance 100.000 Martindale rubs, EN ISO 12947
Flammability EN 1021-1/2 | BS 5852 part 1
 Önorm B1/Q1 | NF D 60 013 | UNI 9175, 11M
 AS/NZS 1530.3 | Cal. Tech. Bull. 117-2013
 NFPA 260 | IMO FTP Code 2010:Part 8
Fastness to light Note 5-7, ISO 105-B02
Fastness to rubbing (ISO) dry 4-5, wet 4
Pilling Note 4, EN ISO 12945
Maintenance Vacuuming and dry cleaning



CAT B — Velvet

Composition 100% PES
Weight 375 g/m² | 11.06 oz/yd²
Width 140 cm | 55.12"
Thickness 0,7mm | 0.0275"
Abrasion resistance >100.000 Martindale
Flammability USA: CAL TB 117
Fastness to light EU: 4-5
Fastness to rubbing EU: Wet 4 | Dry 4-5
Pilling EU: 4-5
Match Weight ±5% | Width ±2%
Maintenance Vacuum clean regularly. Don't wash. Don't remove the Velvet from the product. Treat spillages immediately. Professional dry clean or wipe clean with a pH neutral soap and a damp cloth.



CAT D — Tonus 4 kvadrat

Composition 90% new wool, 10% Helanca
Weight 665 g/lin.m
Width 140 cm | 55.11"
Abrasion resistance 100.000 Martindale rubs, EN ISO 12947
Flammability EN 1021-1/2 | BS 5852 part 1 | DIN 4102 B2
 Önorm B1/Q1 | NF D 60 013 | UNI 9175 11M
 US Cal. Bull. 117-2013 | NFPA 260 | IMO
 A.652 (16)
Fastness to light Note 5-7, ISO 105-B02

Fastness to rubbing (ISO) dry 3-5, wet 3-5
Pilling Note 3, EN ISO 12945
Maintenance Vacuuming and dry cleaning



CAT C — Hero kvadrat

Composition 96% new wool, 4% nylon
Weight 580 g/lin.m
Width 140 cm | 55.11"
Abrasion resistance 45.000 Martindale rubs, EN ISO 12947
Flammability EN 1021-1/2 | DIN 4102 B2 | NF D 60 013
 UNI 9175 11M | US Cal. Bull. 117-2013 |
 NFPA 260
 IMO A.652 (16)

Fastness to light Note 5-6, ISO 105-B02
Fastness to rubbing (ISO) dry 4-5, wet 4-5
Pilling Note 3-4, EN ISO 12945

Maintenance Vacuuming and dry cleaning. Washable at max. 30°C, wool programme. Drip drying. Mount covers in slightly wet condition



CAT E — Memory 2 kvadrat

Composition 100% Trevira CS
Weight 700 g/lin.m
Width 150 cm | 59.05"
Abrasion resistance 35.000 rubs acc. to the Martindale method, EN ISO 12947
Flammability EN 1021-1/2 | DIN 4102 B1 | Önorm B1/Q1
 NF D 60 013 | NF P 92 507 M1 | UNI 9175 11M
 UNI 9177 classe 1 | US Cal. Tech. Bull. 117
 IMO A.652 (16)

Fastness to light Note 5-8, ISO 105-B02
Fastness to rubbing (ISO) dry 4-5, wet 4-5
Pilling Note 4, EN ISO 12945

Maintenance Vacuuming and dry cleaning.
 Washable at max. 60°C. Drip drying.



FELT

BuzziFelt



FE-Anthracite 68

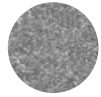

FE-StoneGrey 67



FE-EcoBrown 58



FE-Mokka 74



FE-OffWhite 63



FE-Lime 64

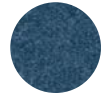

FE-Jeans 75



FE-LightBlue 60



FE-Pink 65



FE-Red 59



FE-Orange 66



FE-Curry 61



CAT A

Fabric



CAT A

Revive 1 kvadrat

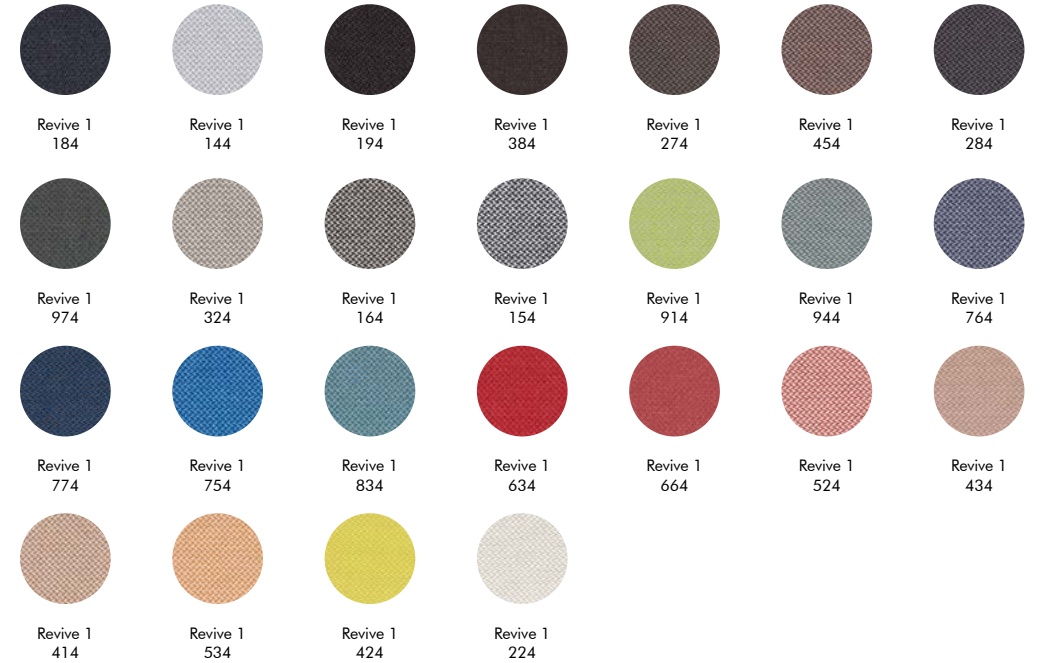

CAT A

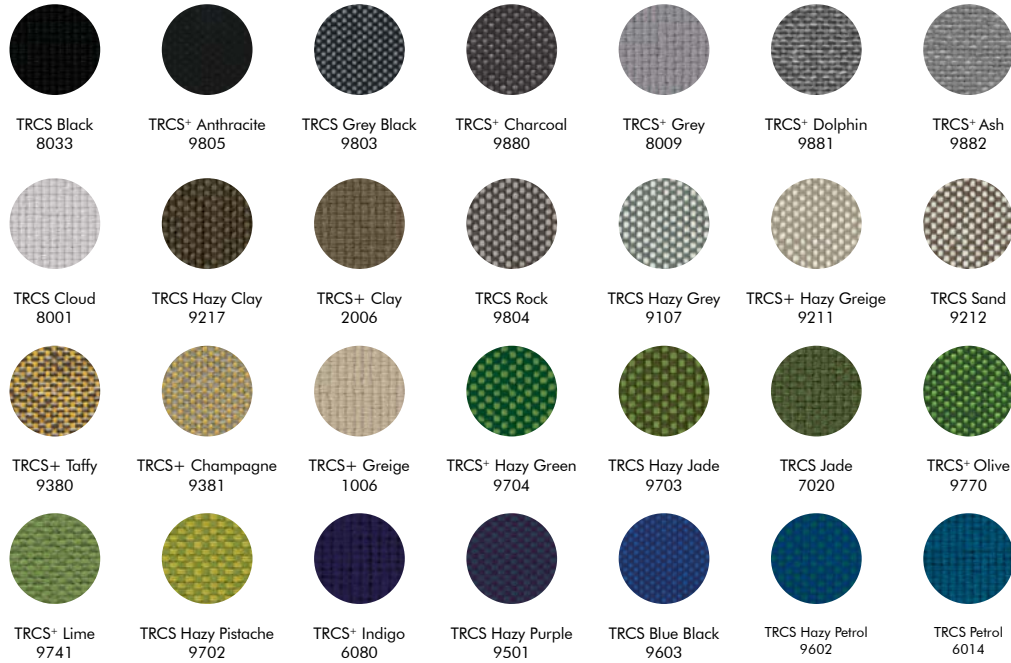

Trevira CS / Trevira CS+

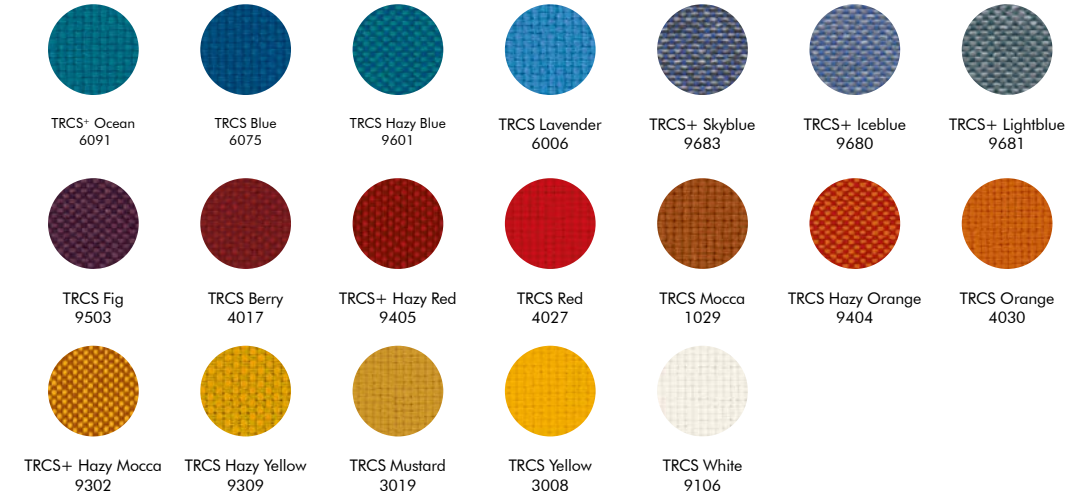

CAT B

Clara 2 kvadrat

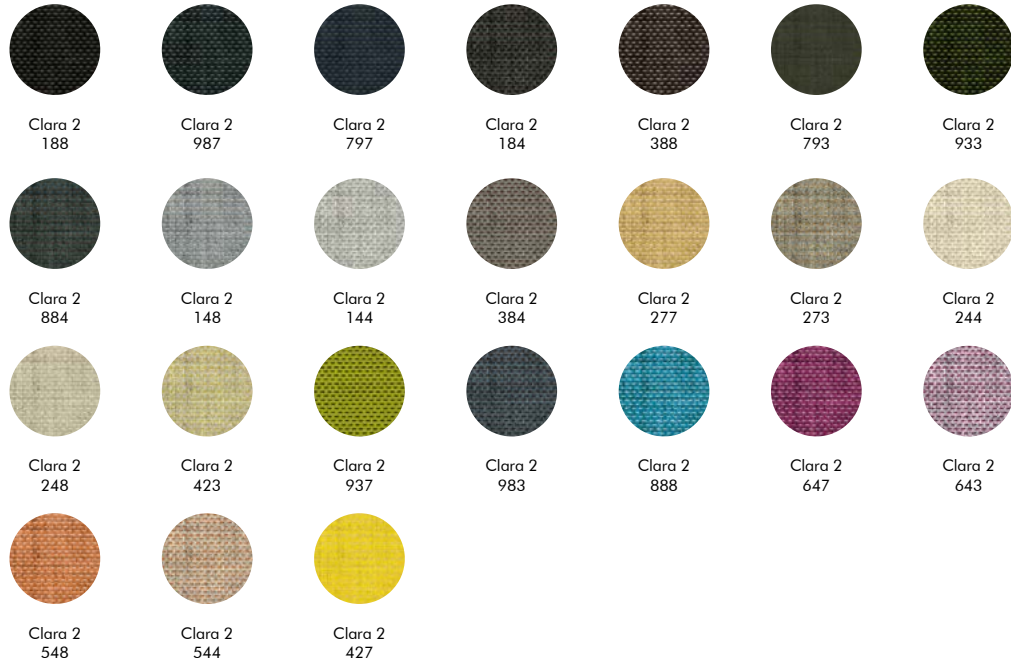

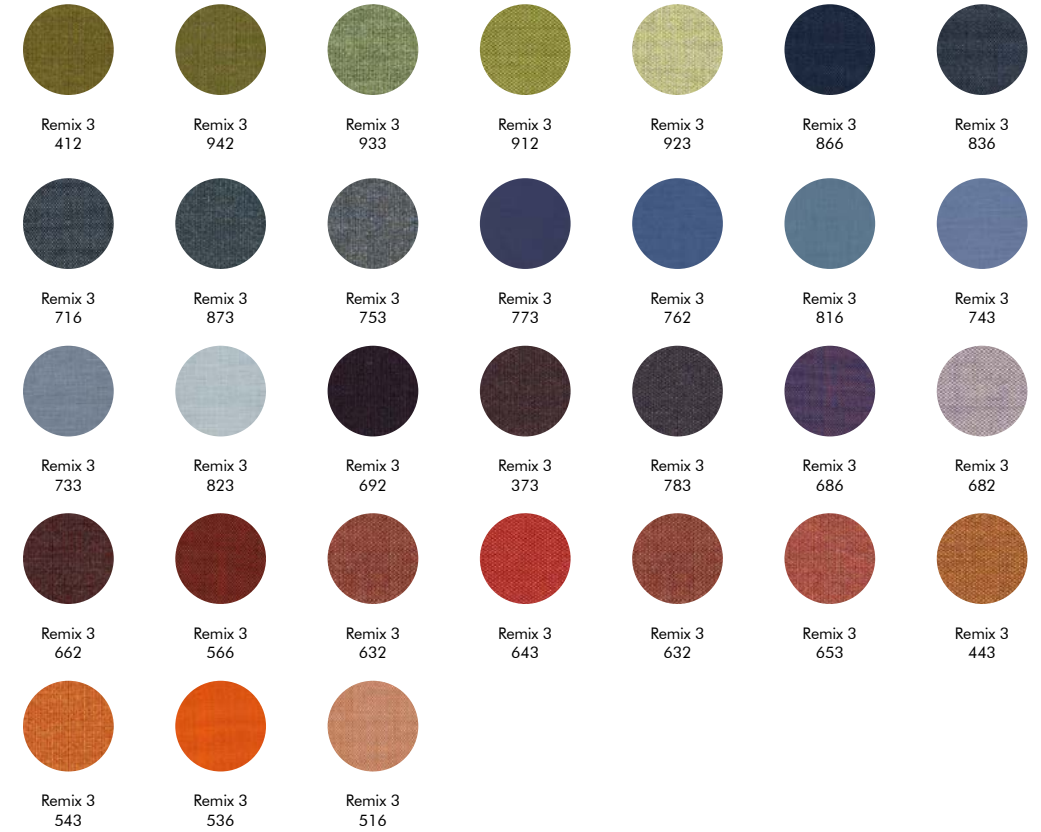

CAT B

Velvet



VE-Emperador
106



VE-Gold
401



VE-Botanic
501



VE-Scarab
505



VE-Crocodile
502



VE-Prussian
606



VE-Peacock
600

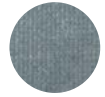

VE-Sky
601



VE-Burgundy
201



VE-Amber
300



VE-Blush
704



VE-Pearl
902

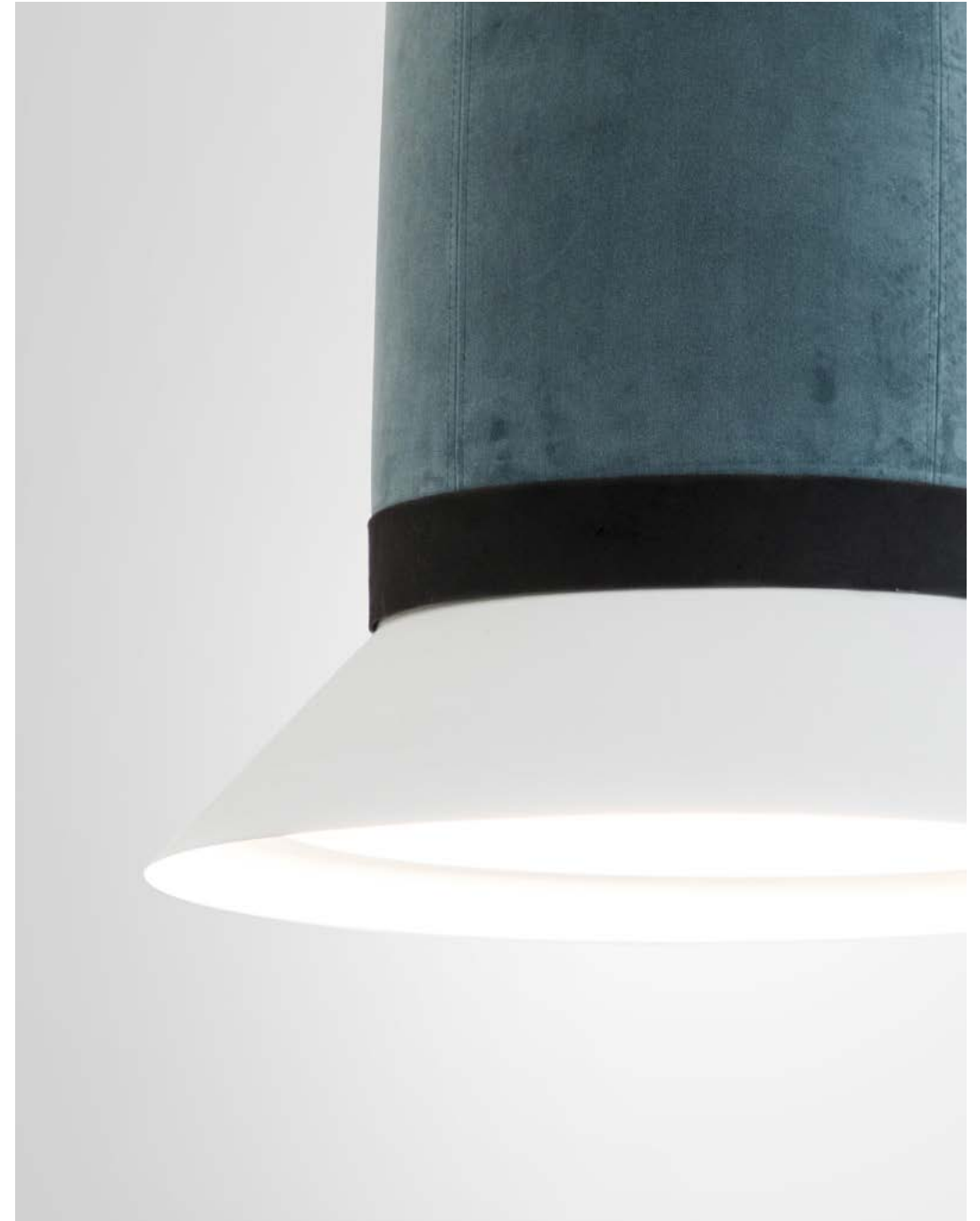

CAT C

Hero kvadrat

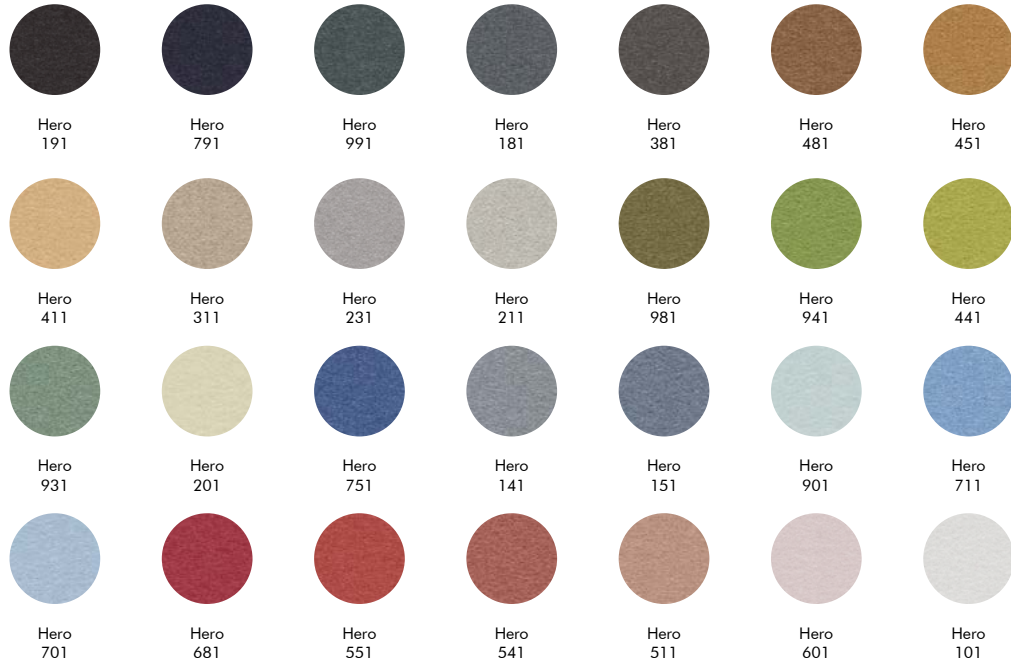

CAT D

Tonus 4 kvadrat



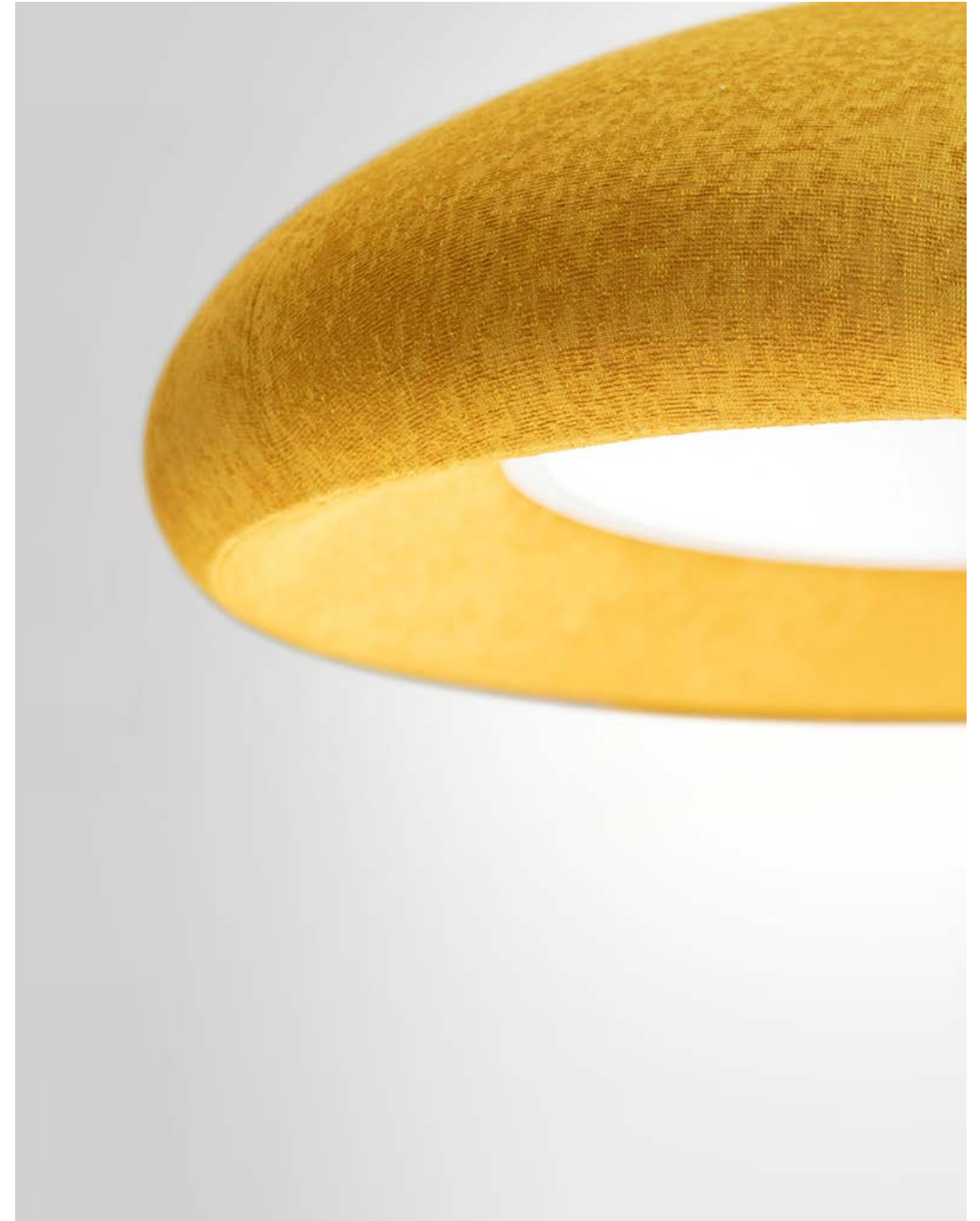

APPLICATION
OVERVIEW METAL

Solid Materials

- Not possible
✔ Possible

Product	Powder-coated Metal						Uncoated Aluminum		
	Black RAL 9005	White RAL 9010	Gold	Fluo Orange RAL 2005	Beige Red RAL 3012	Fluo Yellow RAL 1016			
BuzziBell	Frame	✔	✔	○	○	○	✔	○	
	Ceiling canopy	○	✔	○	○	○	○	○	
BuzziChandelier	Frame	✔	○	○	○	○	○	○	
	Ceiling canopy	✔	○	○	○	○	○	○	
BuzziCone	Frame	✔	○	○	○	○	○	○	
	Ceiling canopy	✔	○	○	○	○	○	○	
BuzziDisk	LED disk	○	✔	○	○	○	○	○	
	Ceiling canopy	✔	○	○	○	○	○	○	
BuzziFez	Frame	✔	○	○	○	○	○	○	
BuzziHat	Shade	✔	✔	✔	○	✔	○	○	
	Ring	✔	✔	✔	○	✔	○	○	
	Ceiling canopy	○	✔	○	○	○	○	○	
BuzziJet	Frame	○	✔	○	○	○	○	○	
	Ceiling canopy	○	✔	○	○	○	○	○	
BuzziJet Standing	Arch	✔	○	○	○	○	○	○	
	Base plate	✔	○	○	○	○	○	○	
BuzziLight Mono	Frame	✔	○	○	○	○	○	○	
	Ceiling canopy	✔	○	○	○	○	○	○	
BuzziMoon	Ceiling canopy	○	✔	○	○	○	○	○	
BuzziPleat Light	Frame	✔	○	○	○	○	○	○	
	Ceiling canopy	✔	○	○	○	○	○	○	
BuzziProp	Frame	✔	○	○	○	○	○	○	
	Ceiling canopy	✔	○	○	○	○	○	○	
BuzziShade	M & L	Frame	✔	✔	○	✔	○	○	✔
		Ceiling canopy Retrofit	✔	✔	○	○	○	○	○
		Ceiling canopy LED	✔	○	○	○	○	○	○
	XL & XXL	Frame	✔	✔	○	○	○	○	✔
		Ceiling canopy LED	○	✔	○	○	○	○	○
BuzziShade Square	Frame	✔	✔	○	✔	○	○	✔	
	Ceiling canopy Retrofit	✔	✔	○	○	○	○	○	
	Ceiling canopy LED	✔	○	○	○	○	○	○	
BuzziShade Standing	Frame	✔	✔	○	○	○	○	○	
BuzziShield Light	Ceiling canopy	✔	○	○	○	○	○	○	
BuzziTrom	Frame	✔	○	○	○	○	○	○	
	Ceiling canopy	○	✔	○	○	○	○	○	
BuzziZepp Light	LED Line	✔	○	○	○	○	○	○	
	Ceiling canopy	✔	○	○	○	○	○	○	

Find the latest update of the application
overview on our website: www.buzzi.space

METAL

Powder-Coated Metal



Black
RAL 9005



White
RAL 9010



Gold



Fluo Orange
RAL 2005



Beige Red
RAL 3012



Fluo Yellow
RAL 1016

Properties Fine-textured powder-coated steel or aluminum with a mat look.

Maintenance Clean as needed using a soft cloth or brush with a mild detergent.

Avoid steam cleaning, abrasive cleansers, carbon steel brushes/wools and cleaners containing chlorine.

Uncoated Aluminum



Properties Bare aluminum with clear coating.

Maintenance Clean as needed using a soft cloth or brush with a mild detergent.

Avoid steam cleaning, abrasive cleansers, carbon steel brushes/wools and cleaners containing chlorine.

Refinishing should be done by a specialist in furniture coating.

It requires sanding of the parts and re-applying an equal amount of coating on all sides.



Note color deviation may occur. Find the latest update of the material specifications and colors on our website: www.buzzi.space

Publisher

Responsible Editor

BuzziSpace
Groeningenlei 141
BE-2550 Antwerp - Kontich
Marketing Department

Editorial

Mallory Chin
Dada Goldberg
Els Kerckhof
Romina Rico
Sarah Van Vlierberghe

Photography

Mariola Zolodz
Maxime Brouillet
Andrea Liverani
Christine Strub
Leon Hargreaves
MHK Photography
Brian Gassel
Andrei Tudoran
Santi Caleca
Andrea Bartoluccio
Chris Bradley
Siobhan Doran

Contact

BuzziSpace HQ

Groeningenlei 141
2550 Antwerp - Kontich
Belgium
info@buzzi.space
+32 3 846 10 00

Office | Manufacturing The Netherlands

Industrieweg 7a
5531 AD Bladel
The Netherlands
manufacture@buzzi.space
+31 497 387 478

Sh'Office New York

45 West 21st Street - 3rd floor
NY 10010
USA
us@buzzi.space
+1 336 821 3150

Sh'Office Chicago

222 Merchandise Mart Plaza Suite
10-111
Chicago, IL 60651
USA
us@buzzi.space
+1 336 821 3150

Worldwide BuzziSpace sales network: www.buzzi.space

For any updates, please refer to the online version of the Acoustic Lighting catalog via www.buzzi.space. The online version will take precedence.

